

HAKKIMIZDA

ABOUT US



KIRIMCI METAL FORM SAN. TİC. A.Ş , Kurucumuz Nazmi KIRIMCI'nın ferforje ve makine sektöründeki 30 yıllık tecrübe birikimiyle, 2014 yılında Bursa'da faaliyete geçmiştir.

Firmamızda geniş makine parkurumuzla; lazer kesimli sac, desenli sac, çelik kapı panelleri, genişletilmiş metal, boğumlu boru, ferforje motif ve kapı elemanları imalatı yapılmaktadır. ISO 9001 Kalite Sistem Belgesi'ne sahip firmamız, "Yüksek kalite-Hızlı sevkiyat-İyi hizmet" anlayışı ile kısa sürede hızlı bir ivme ile büyümüş, dünyanın dört bir yanına ürünlerini gönderir hale gelmiştir. Yurtiçindeki birçok bayimizin yanı sıra, firmamız hali hazırda yaklaşık 40 ülkeye ihracat yapmaktadır.

10,000 m²'lik fabrikamızda; Tasarım Ekibimizle ürün yelpazemize sürekli olarak yenilerini ekleyerek; yüksek kapasite ve teknolojik imkanlarımızla gerek yurtiçi gerek yurtdışın pazarındaki müşterilerimize sac şekillendirme ürünleri alanında hızlı ve güvenilir hizmet vermekteyiz.

Avrupa standartlarında üretim kalitesi ile ürünler üreten firmamız, AR-GE ekibi ile üretim teknolojisini her geçen gün iyileştirerek müşterilerine yüksek kalitedeki ürünleri rekabetçi fiyatlarla sunmaktadır.



KIRIMCI METAL FORM SAN. TİC. A.Ş started its operations in Bursa in 2014, with the 30 years of experience of our Founder Nazmi KIRIMCI in the wrought iron and machinery industry.





















Laser cut sheet metal, patterned sheet metal, steel door panels, expanded metal, ribbed pipes, wrought iron motifs and door elements are manufactured in our company in our wide machine park. Our company, which has ISO 9001 Quality System Certificate, has grown fastly in a short time with the mission of "High quality-Fast shipping-Good service" and has become to send its products all over the world. In addition to many of our domestic dealers, our company currently exports to approximately 40 countries.

In our 10,000 m² factory; by constantly adding new products to our product range with our Design Team; we provide fast and reliable service to our customers in both domestic and foreign markets in the field of sheet metal forming products.

Our company have production quality in European standards and we improve our production technology day by day with our R&D team.

İÇİNDEKİLER

CONTENTS

GENİŞLETİLMİŞ METAL & DELİKLİ SAC <i>EXPANDED METAL & PERFORATED SHEETS</i>		04
BOĞUMLU VE NERVÜRLÜ BORULAR <i>RIBBED AND GNARLED PIPES</i>		12
DEKORATİF LAMALAR - PROFİLLER - KÜPEŞTELER - ALÜMİNYUM KAPAKLAR <i>DECORATIVE FLAT BARS - PROFILES - HANDRAILS - ALUMINIUM LIDS</i>		20
MOTİFLİ ÇUBUKLAR <i>BALUSTRADES</i>		24
C MOTİFLER - S MOTİFLER <i>ORNAMENTAL SCROLLS</i>		34
DEKORATİF FERFORJE PANELLER - ÜZÜM DALLARI VE PANELLERİ <i>DECORATIVE WUGHT IRON PANELS - GRAPE RODS AND PANELS</i>		38
BAĞLANTI ELEMANLARI - MIZRAKLAR - KELEPÇELER <i>CONNECTION ACCESSORIES - SPEARHEADS - COLLAR STRIPS</i>		52
KOZALAKLAR - KOZALAKLI ÇUBUKLAR <i>BASKETS - BASKET BARS</i>		54
KÜRELER - HALKALAR - KABARALAR <i>SPHERES - RINGS - RIVETS</i>		55
FLANŞLAR <i>FLANGES</i>		56
BORU & PROFİL KAPAKLARI VE FLANŞLARI <i>PIPE & PROFILE LIDS AND FLANGES</i>		58
DÖVME ROZETLER <i>FORGED ROSETTES</i>		61
ROZETLER - YAPRAKLAR - SAC MOTİFLER <i>ROSETTES - LEAVES - SHEET MOTIFS</i>		62
SAC GÖBEKLER <i>SHEET CENTERS</i>		70
SAC BORDÜRLER <i>SHEET CENTERS</i>		74
DEKORATİF MENTEŞELER - KİLİT KARŞILIKLARI <i>DECORATIVE HINGES - LOCK STRIKE PLATES</i>		78
DEKORATİF KAPI KOLLARI <i>DECORATIVE DOOR HANDLES</i>		82
KAPI ELEMANLARI <i>GATE ACCESSORIES</i>		84
DÖKÜM ÜRÜNLER <i>CAST IRON PRODUCTS</i>		92
BAHÇE - DIŞ MEKAN ÜRÜNLERİ <i>GARDEN - OUTDOOR PRODUCTS</i>		94
HARFLER - SAYILAR - PATİNA BOYALAR <i>LETTERS - NUMBERS - PATINA PAINTS</i>		97

1- Rulo
Roll

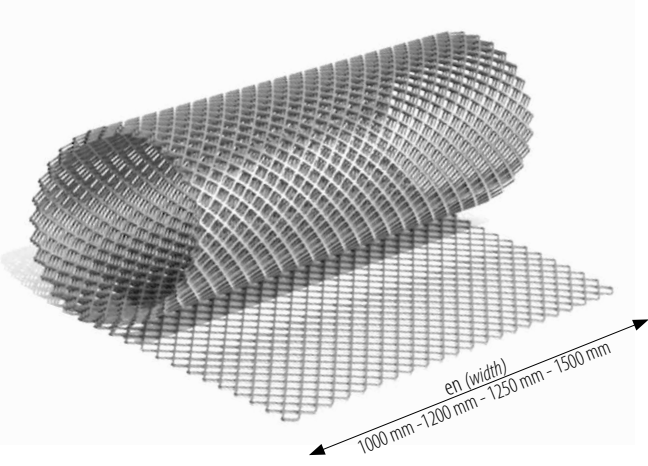

3- Göz Detayı
Diamond Measure

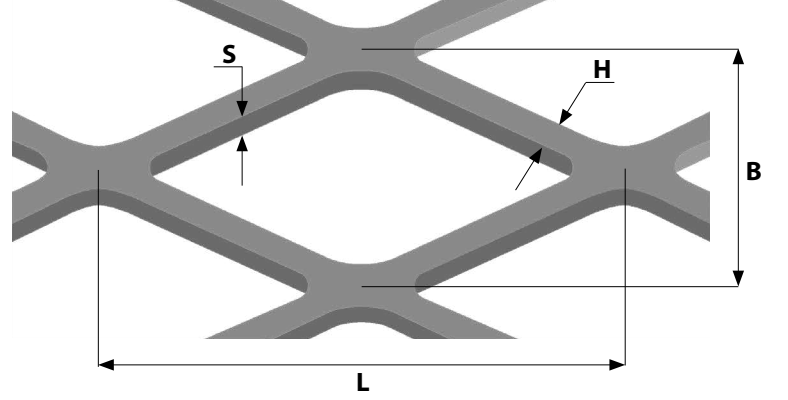

L = uzunluk
braid length

B = geniřlik
braid width

S = sac kalınlığı
sheet thickness

H = hatve
strip width

2- Sac Boyutu (en & boy)
Metal Sheet Size (width & length)

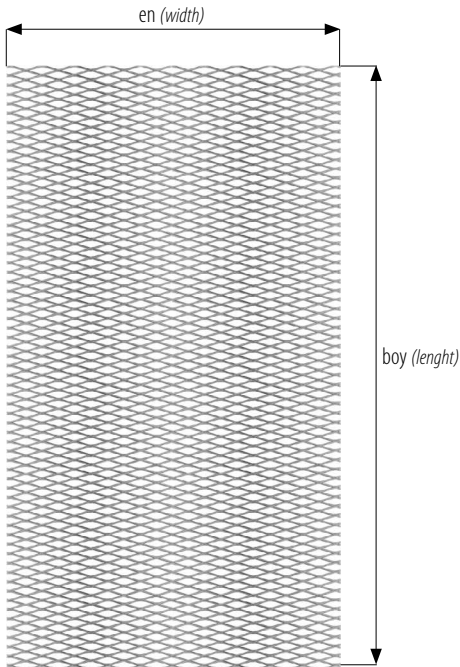

sac ölçüleri (en&boy)
metal sheet size (width & length)

1000x2000mm
1200x2400mm
1250x2500mm
1500x3000mm

4- Geniřletilmiř Metal - Düzleřtirilmiř Geniřletilmiř Metal
Expanded Metal vs. Flattened Expanded Metal

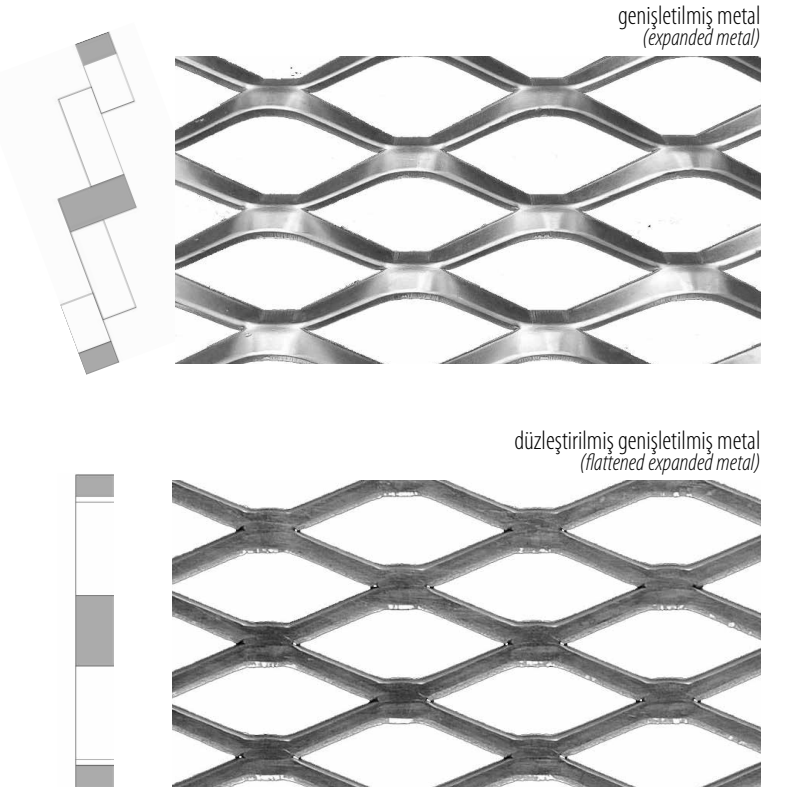

BAKLAVA DESENLI GENIřLETILMIř SACLAR / DIAMOND PATTERNED EXPANDED METAL

KOD CODE	GÖZARALIĐI (mm) BRAID WIDTH x BRAID LENGHT	SAC KALINLIĐI S (mm) SHEET THICKNESS	HATVE H (mm) STRIP WIDTH	EBATLAR DIMENSION			EBATLAR DIMENSION			EBATLAR DIMENSION			EBATLAR DIMENSION		
				EN (mm) WIDTH	BOY (mm) LENGHT	AĐIRLIK (m ² /kg) WEIGHT	EN (mm) WIDTH	BOY (mm) LENGHT	AĐIRLIK (m ² /kg) WEIGHT	EN (mm) WIDTH	BOY (mm) LENGHT	AĐIRLIK (m ² /kg) WEIGHT	EN (mm) WIDTH	BOY (mm) LENGHT	AĐIRLIK (m ² /kg) WEIGHT
0700	10/5	0,5	1	1000	2000	3,20	-	-	-	-	-	-	-	-	-
		1	1	1000	2000	6,40	-	-	-	-	-	-	-	-	-
0701	13/7	1	1	1000	2000	4,60	-	-	-	-	-	-	-	-	-
		1,5	2	1000	2000	13,70	-	-	-	-	-	-	-	-	-
0702-A	20/8	1	2	1000	2000	7,85	1200	2400	11,30	1250	2500	12,27	1500	3000	17,66
		1,5	2,5	1000	2000	14,72	1200	2400	21,20	1250	2500	23,00	1500	3000	33,12
		2	3	1000	2000	23,55	1200	2400	33,91	1250	2500	36,80	1500	3000	52,99
0702	25/8	1	2	1000	2000	8,00	1200	2400	11,52	1250	2500	12,50	1500	3000	18,00
		1,5	2,5	1000	2000	15,00	1200	2400	21,60	1250	2500	23,44	1500	3000	33,75
		2	3	1000	2000	24,60	1200	2400	35,43	1250	2500	38,44	1500	3000	55,35
0703	30/13	1	2	1000	2000	4,80	1200	2400	6,91	1250	2500	7,50	1500	3000	10,80
		1,5	2,5	1000	2000	9,20	1200	2400	13,25	1250	2500	14,38	1500	3000	20,70
		2	3	1000	2000	14,80	1200	2400	21,32	1250	2500	23,13	1500	3000	33,30
		3	4	1000	2000	29,00	1200	2400	41,75	1250	2500	45,31	1500	3000	65,25
0704-A	40/20	1	2	1000	2000	3,14	1200	2400	4,52	1250	2500	4,91	1500	3000	7,07
		1,5	2,5	1000	2000	5,89	1200	2400	8,48	1250	2500	9,20	1500	3000	13,25
		2	3	1000	2000	9,42	1200	2400	13,56	1250	2500	14,72	1500	3000	21,20
		3	4	1000	2000	18,84	1200	2400	27,13	1250	2500	29,44	1500	3000	42,39
0704	42/14	1	2	1000	2000	4,60	1200	2400	6,63	1250	2500	7,19	1500	3000	10,35
		1,5	2,5	1000	2000	8,60	1200	2400	12,39	1250	2500	13,44	1500	3000	19,35
		2	3	1000	2000	13,60	1200	2400	19,58	1250	2500	21,25	1500	3000	30,60
		3	4	1000	2000	27,40	1200	2400	39,45	1250	2500	42,81	1500	3000	61,65
0705	50/18	1	2	1000	2000	4,60	1200	2400	6,63	1250	2500	7,19	1500	3000	10,35
		1,5	2,5	1000	2000	8,60	1200	2400	12,39	1250	2500	13,44	1500	3000	19,35
		2	3	1000	2000	13,60	1200	2400	19,58	1250	2500	21,25	1500	3000	30,60
		3	4	1000	2000	27,40	1200	2400	39,45	1250	2500	42,81	1500	3000	61,65
0706	62/24	1,5	2,5	1000	2000	6,60	1200	2400	9,50	1250	2500	10,31	1500	3000	14,85
		2	3	1000	2000	10,60	1200	2400	15,26	1250	2500	16,56	1500	3000	23,85
		3	4	1000	2000	21,20	1200	2400	30,53	1250	2500	33,13	1500	3000	47,70
		4	5	1000	2000	35,40	1200	2400	50,97	1250	2500	55,31	1500	3000	79,65
0707	76/31	1,5	2,5	1000	2000	6,60	1200	2400	9,50	1250	2500	10,31	1500	3000	14,85
		2	3	1000	2000	10,60	1200	2400	15,26	1250	2500	16,56	1500	3000	23,85
		3	4	1000	2000	21,20	1200	2400	30,53	1250	2500	33,13	1500	3000	47,70
		4	5	1000	2000	35,40	1200	2400	50,97	1250	2500	55,31	1500	3000	79,65
0708	82/24	2	3	1000	2000	8,10	1200	2400	11,66	1250	2500	12,66	1500	3000	18,23
		3	4	1000	2000	16,00	1200	2400	23,04	1250	2500	25,00	1500	3000	36,00
		3	7	1000	2000	26,00	1200	2400	37,44	1250	2500	40,63	1500	3000	58,50
		4	5	1000	2000	28,60	1200	2400	41,18	1250	2500	44,69	1500	3000	64,35
0709	94/38	4	7	1000	2000	37,00	1200	2400	53,27	1250	2500	57,81	1500	3000	83,25
		5	6	1000	2000	40,00	1200	2400	57,60	1250	2500	62,50	1500	3000	90,00
		5	7	1000	2000	46,00	1200	2400	66,24	1250	2500	71,88	1500	3000	103,50
		2	3	1000	2000	8,10	1200	2400	11,66	1250	2500	12,66	1500	3000	18,23
0710	110/45	2	2,5	1000	2000	5,20	1200	2400	7,49	1250	2500	8,13	1500	3000	11,70
		3	4	1000	2000	12,40	1200	2400	17,86	1250	2500	19,38	1500	3000	27,90
		4	5	1000	2000	20,40	1200	2400	29,38	1250	2500	31,88	1500	3000	45,90
		5	6	1000	2000	31,20	1200	2400	44,92	1250	2500	48,75	1500	3000	70,20
0710-A	100/50	2	3	1000	2000	5,00	1200	2400	7,19	1250	2500	7,81	1500	3000	11,25
		3	4	1000	2000	10,00	1200	2400	14,40	1250	2500	15,63	1500	3000	22,50
		4	5	1000	2000	16,80	1200	2400	24,19	1250	2500	26,25	1500	3000	37,80
		5	6	1000	2000	25,20	1200	2400	36,29	1250	2500	39,38	1500	3000	56,70
0711	110/45	3	4	1000	2000	7,54	1200	2400	10,85	1250	2500	11,78	1500	3000	16,96
		4	5	1000	2000	12,56	1200	2400	18,09	1250	2500	19,63	1500	3000	28,26
		5	6	1000	2000	18,84	1200	2400	27,13	1250	2500	29,44	1500	3000	42,39
0711	110/45	3	4	1000	2000	8,60	1200	2400	12,38	1250	2500	13,44	1500	3000	19,35
		4	5	1000	2000	14,00	1200	2400	20,16	1250	2500	21,88	1500	3000	31,50
		5	6	1000	2000	21,20	1200	2400	30,52	1250	2500	33,13	1500	3000	47,70

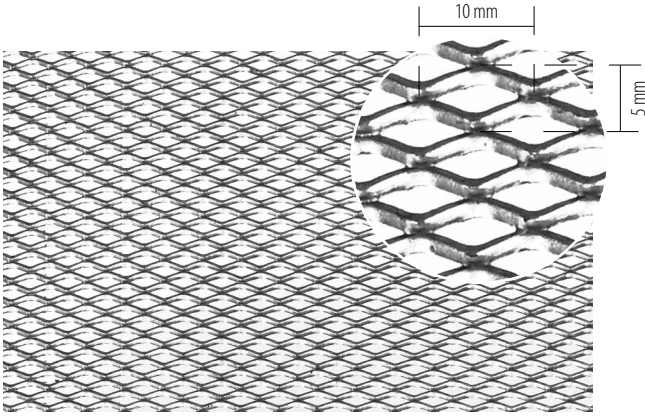

Kod Code	Göz Aralığı G (mm) Braid Width x Braid Length	Sac Kalınlığı S (mm) Sheet Thickness	Hatve H (mm) Strip Width	Ölçü (mm) Dimension		
				En (mm) Width	Boy (mm) Length	Ağırlık (m ² /kg) Weight
0700	10/5	0.5	1	1000	2000	3.20
		1	1	1000	2000	6.40

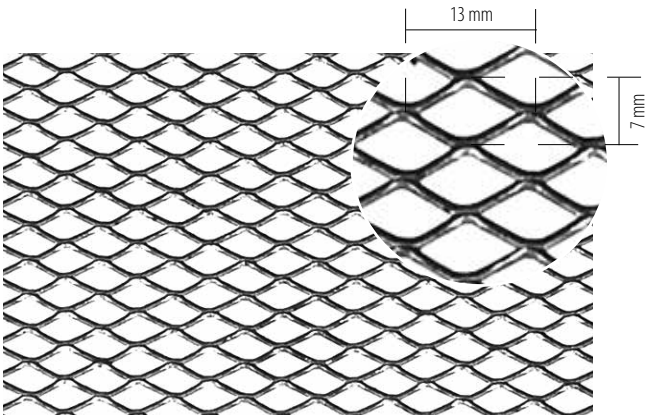

Kod Code	Göz Aralığı G (mm) Braid Width x Braid Length	Sac Kalınlığı S (mm) Sheet Thickness	Hatve H (mm) Strip Width	Ölçü (mm) Dimension		
				En (mm) Width	Boy (mm) Length	Ağırlık (m ² /kg) Weight
0701	13/7	1	1	1000	2000	4.60
		1.5	2	1000	2000	13.70

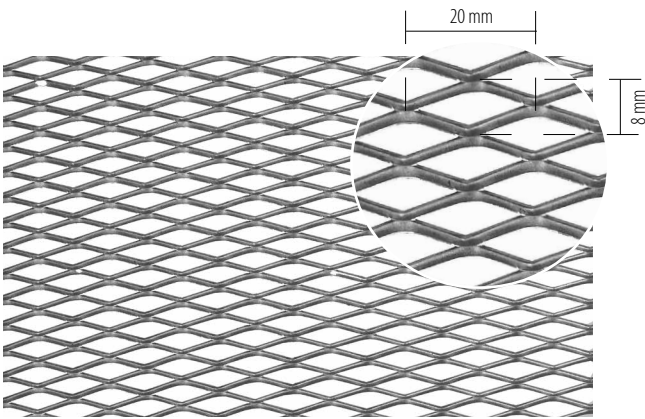

Kod Code	Göz Aralığı G (mm) Braid Width x Braid Length	Sac Kalınlığı S (mm) Sheet Thickness	Hatve H (mm) Strip Width	Ölçü (mm) Dimension		
				En (mm) Width	Boy (mm) Length	Ağırlık (m ² /kg) Weight
0702-A	20/8	1	2	1000	2000	7.85
		1.5	2.5	1000	2000	14.72
		2	3	1000	2000	23.55

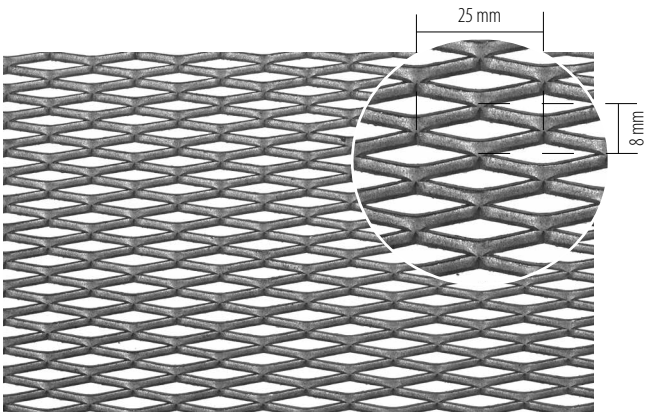

Kod Code	Göz Aralığı G (mm) Braid Width x Braid Length	Sac Kalınlığı S (mm) Sheet Thickness	Hatve H (mm) Strip Width	Ölçü (mm) Dimension		
				En (mm) Width	Boy (mm) Length	Ağırlık (m ² /kg) Weight
0702	25/8	1	2	1000	2000	8.00
		1.5	2.5	1000	2000	15.00
		2	3	1000	2000	24.60

1200x2400mm-1250x2500mm-1500x3000mm ölçü alternatiflerinde de üretilebilir.

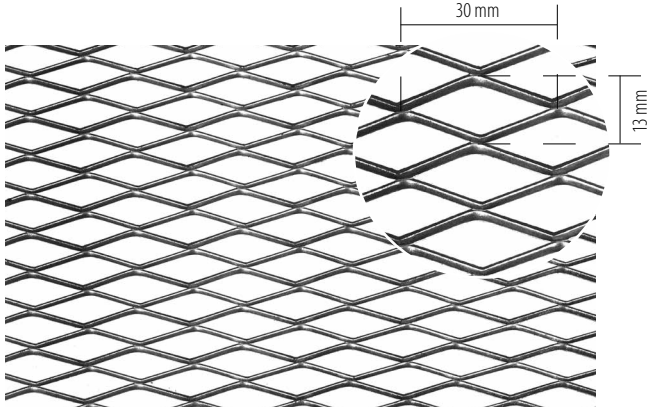

Kod Code	Göz Aralığı G (mm) Braid Width x Braid Length	Sac Kalınlığı S (mm) Sheet Thickness	Hatve H (mm) Strip Width	Ölçü (mm) Dimension		
				En (mm) Width	Boy (mm) Length	Ağırlık (m ² /kg) Weight
0703	30/13	1	2	1000	2000	4.80
		1.5	2.5	1000	2000	9.20
		2	3	1000	2000	14.80
		3	4	1000	2000	29.00

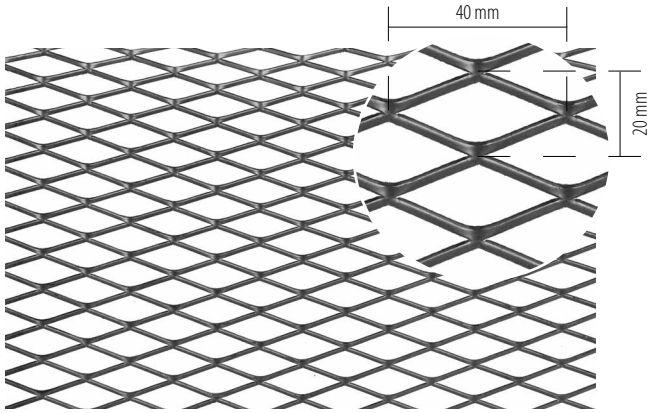

Kod Code	Göz Aralığı G (mm) Braid Width x Braid Length	Sac Kalınlığı S (mm) Sheet Thickness	Hatve H (mm) Strip Width	Ölçü (mm) Dimension		
				En (mm) Width	Boy (mm) Length	Ağırlık (m ² /kg) Weight
0704-A	40/20	1	2	1000	2000	3.14
		1.5	2.5	1000	2000	5.89
		2	3	1000	2000	9.42
		3	4	1000	2000	18.84
		4	5	1000	2000	31.40

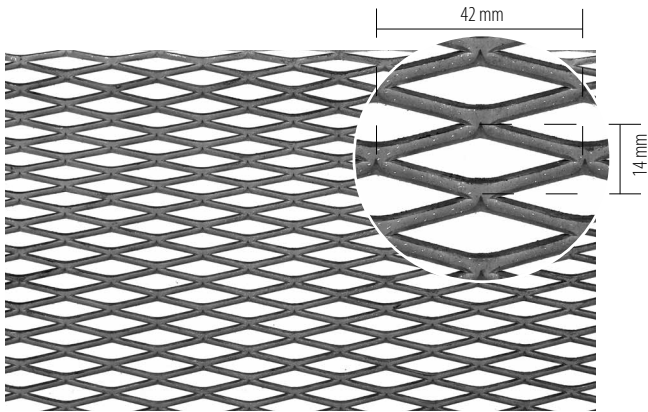

Kod Code	Göz Aralığı G (mm) Braid Width x Braid Length	Sac Kalınlığı S (mm) Sheet Thickness	Hatve H (mm) Strip Width	Ölçü (mm) Dimension		
				En (mm) Width	Boy (mm) Length	Ağırlık (m ² /kg) Weight
0704	42/14	1	2	1000	2000	4.60
		1.5	2.5	1000	2000	8.60
		2	3	1000	2000	13.60
		3	4	1000	2000	27.40
		4	5	1000	2000	45.60

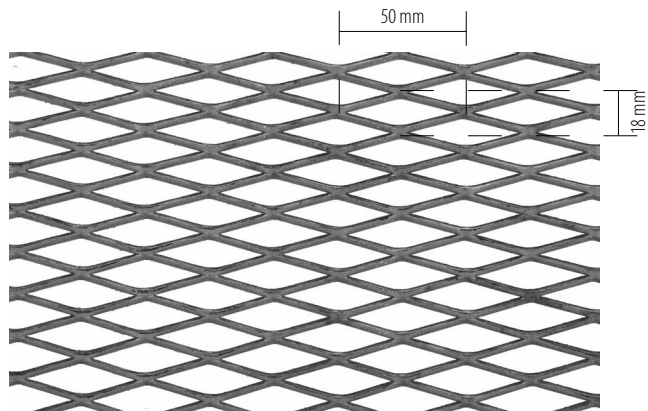

Kod Code	Göz Aralığı G (mm) Braid Width x Braid Length	Sac Kalınlığı S (mm) Sheet Thickness	Hatve H (mm) Strip Width	Ölçü (mm) Dimension		
				En (mm) Width	Boy (mm) Length	Ağırlık (m ² /kg) Weight
0705	50/18	1.5	2.5	1000	2000	6.60
		2	3	1000	2000	10.60
		3	4	1000	2000	21.20
		4	5	1000	2000	35.40
		5	6	1000	2000	53.20

It can also be produced in 1200x2400mm-1250x2500mm-1500x3000mm size alternatives.

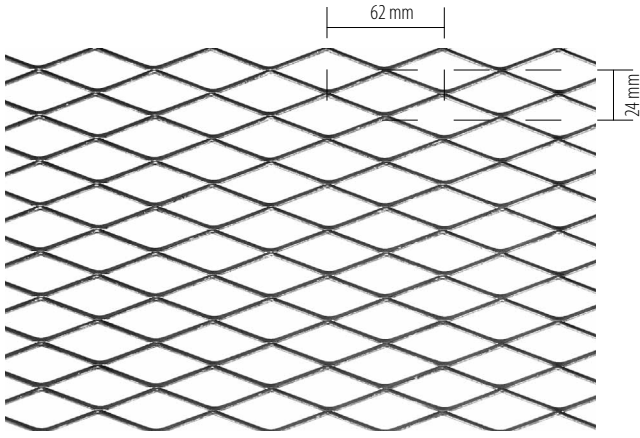

Kod Code	Göz Aralığı G (mm) Braid Width x Braid Length	Sac Kalınlığı S (mm) Sheet Thickness	Hatve H (mm) Strip Width	Ölçü (mm) Dimension		
				En (mm) Width	Boy (mm) Length	Ağırlık (m ² /kg) Weight
0706	62/24	2	3	1000	2000	8.10
		3	4	1000	2000	16.00
		3	7	1000	2000	26.00
		4	5	1000	2000	28.60
		4	7	1000	2000	37.00
		5	6	1000	2000	40.00
		5	7	1000	2000	46.00

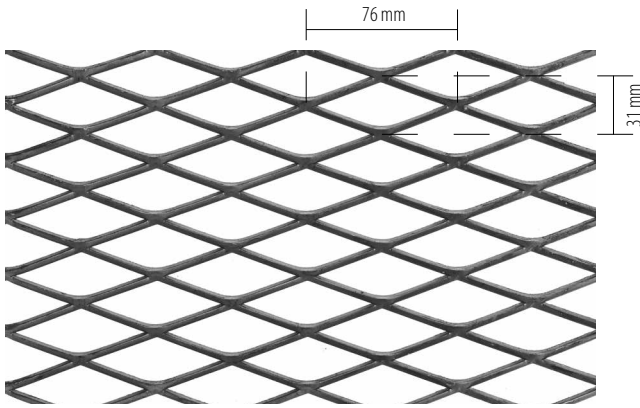

Kod Code	Göz Aralığı G (mm) Braid Width x Braid Length	Sac Kalınlığı S (mm) Sheet Thickness	Hatve H (mm) Strip Width	Ölçü (mm) Dimension		
				En (mm) Width	Boy (mm) Length	Ağırlık (m ² /kg) Weight
0708	76/31	2	2.5	1000	2000	5.20
		3	4	1000	2000	12.40
		4	5	1000	2000	20.40
		5	6	1000	2000	31.20

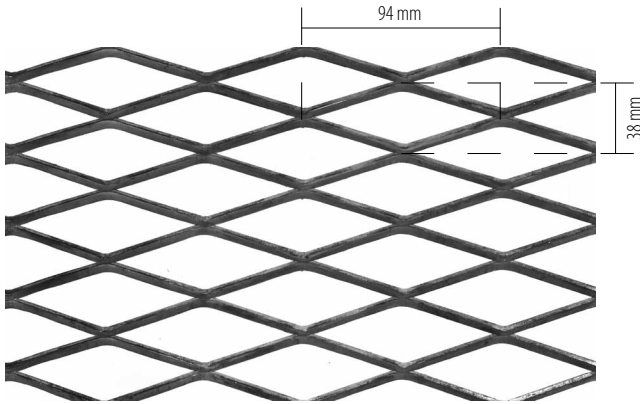

Kod Code	Göz Aralığı G (mm) Braid Width x Braid Length	Sac Kalınlığı S (mm) Sheet Thickness	Hatve H (mm) Strip Width	Ölçü (mm) Dimension		
				En (mm) Width	Boy (mm) Length	Ağırlık (m ² /kg) Weight
0709	94/38	2	3	1000	2000	5.00
		3	4	1000	2000	10.00
		4	5	1000	2000	16.80
		5	6	1000	2000	25.20

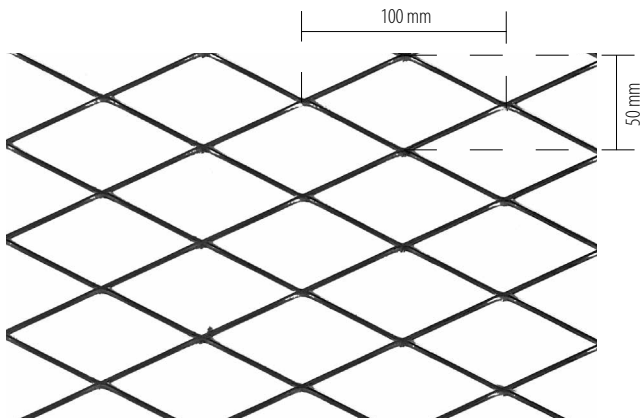

Kod Code	Göz Aralığı G (mm) Braid Width x Braid Length	Sac Kalınlığı S (mm) Sheet Thickness	Hatve H (mm) Strip Width	Ölçü (mm) Dimension		
				En (mm) Width	Boy (mm) Length	Ağırlık (m ² /kg) Weight
0710-A	100/50	3	4	1000	2000	7.54
		4	5	1000	2000	12.56
		5	6	1000	2000	18.84

1200x2400mm-1250x2500mm-1500x3000mm ölçü alternatiflerinde de üretilebilir.

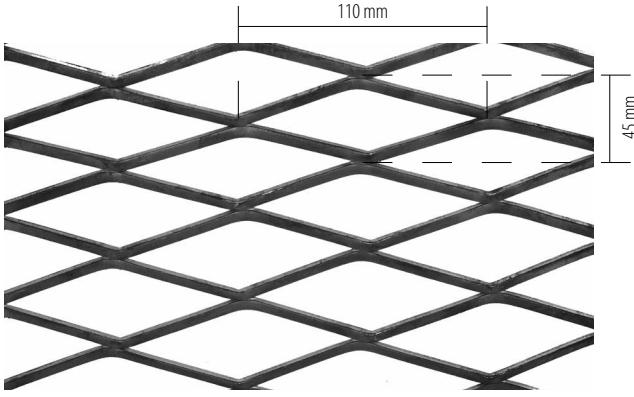

Kod Code	Göz Aralığı G (mm) Braid Width x Braid Length	Sac Kalınlığı S (mm) Sheet Thickness	Hatve H (mm) Strip Width	Ölçü (mm) Dimension		
				En (mm) Width	Boy (mm) Length	Ağırlık (m ² /kg) Weight
0710	110/45	3	4	1000	2000	8.60
		4	5	1000	2000	14.00
		5	6	1000	2000	21.20

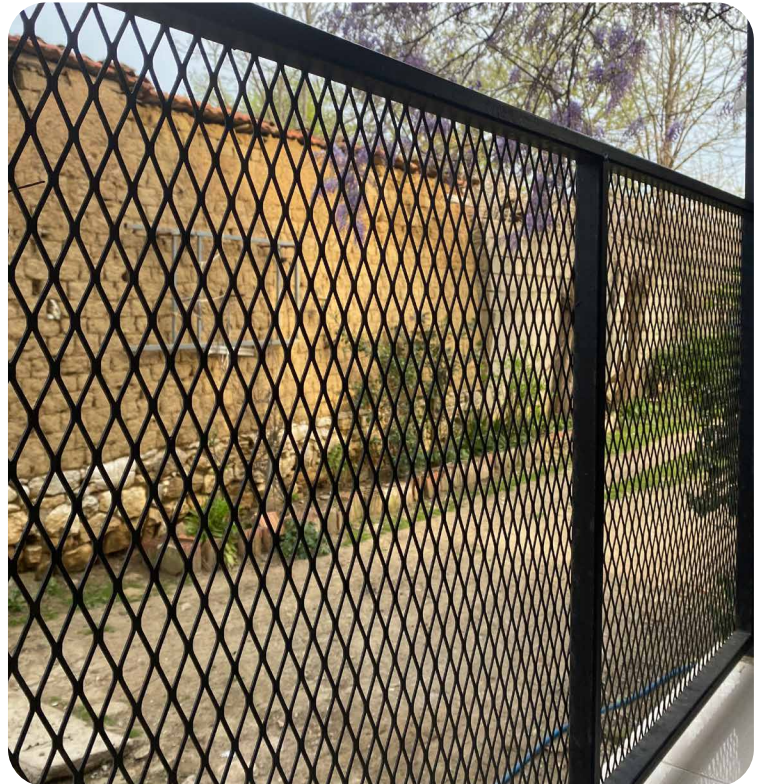

It can also be produced in 1200x2400mm-1250x2500mm-1500x3000mm size alternatives.

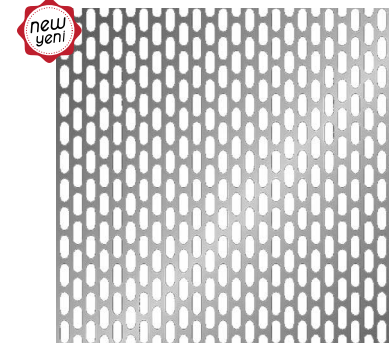
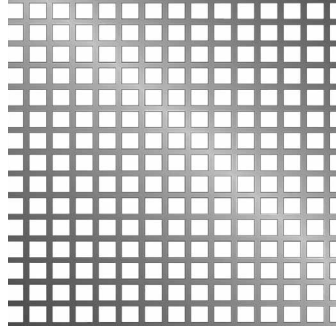
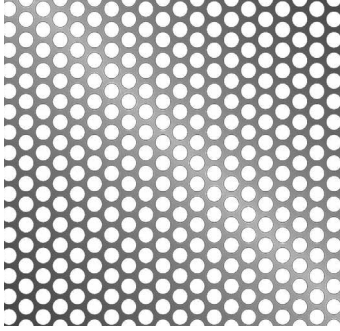
Delikli Saclar - Perforated Sheets

Yuvarlak Delikli Saclar Round Shaped Perforated Sheets			
Kod Code	Delik Çapı Hole Size	Sac Kalınlığı Thickness	Tabaka Ölçüsü Plate Dimension
0771	Ø 3 mm	1 mm	1000x2000 mm
0772	Ø 4 mm	1 mm	1000x2000 mm
0773	Ø 6 mm	1 mm	1000x2000 mm
0774	Ø 8 mm	1 mm	1000x2000 mm
0775	Ø 10 mm	1 mm	1000x2000 mm

Kare Delikli Saclar Square Shaped Perforated Sheets			
Kod Code	Delik Çapı Hole Size	Sac Kalınlığı Thickness	Tabaka Ölçüsü Plate Dimension
0780	5x5 mm	1 mm	1000x2000 mm
0781	8x8 mm	1 mm	1000x2000 mm
0782	10x10 mm	1 mm	1000x2000 mm
0783	15x15 mm	1 mm	1000x2000 mm
0784	20x20 mm	1 mm	1000x2000 mm

Oval Delikli Saclar Oval Shaped Perforated Sheets			
Kod Code	Delik Çapı Hole Size	Sac Kalınlığı Thickness	Tabaka Ölçüsü Plate Dimension
0785	2x20 mm	1 mm	1000x2000 mm
0786	3x20 mm	1 mm	1000x2000 mm
0787	5x20 mm	1 mm	1000x2000 mm
0788	8x20 mm	1 mm	1000x2000 mm

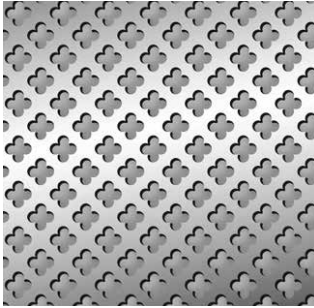
Dekoratif Delikli Saclar - Decorative Perforated Sheets

0790
1 mm 1000x2000 mm

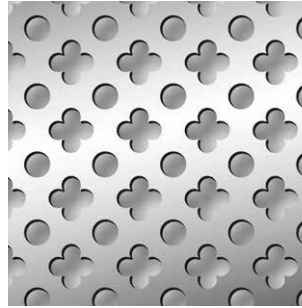

0791
1 mm 1000x2000 mm

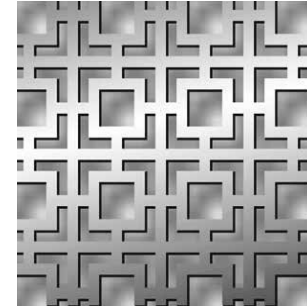

0793
1 mm 1000x2000 mm



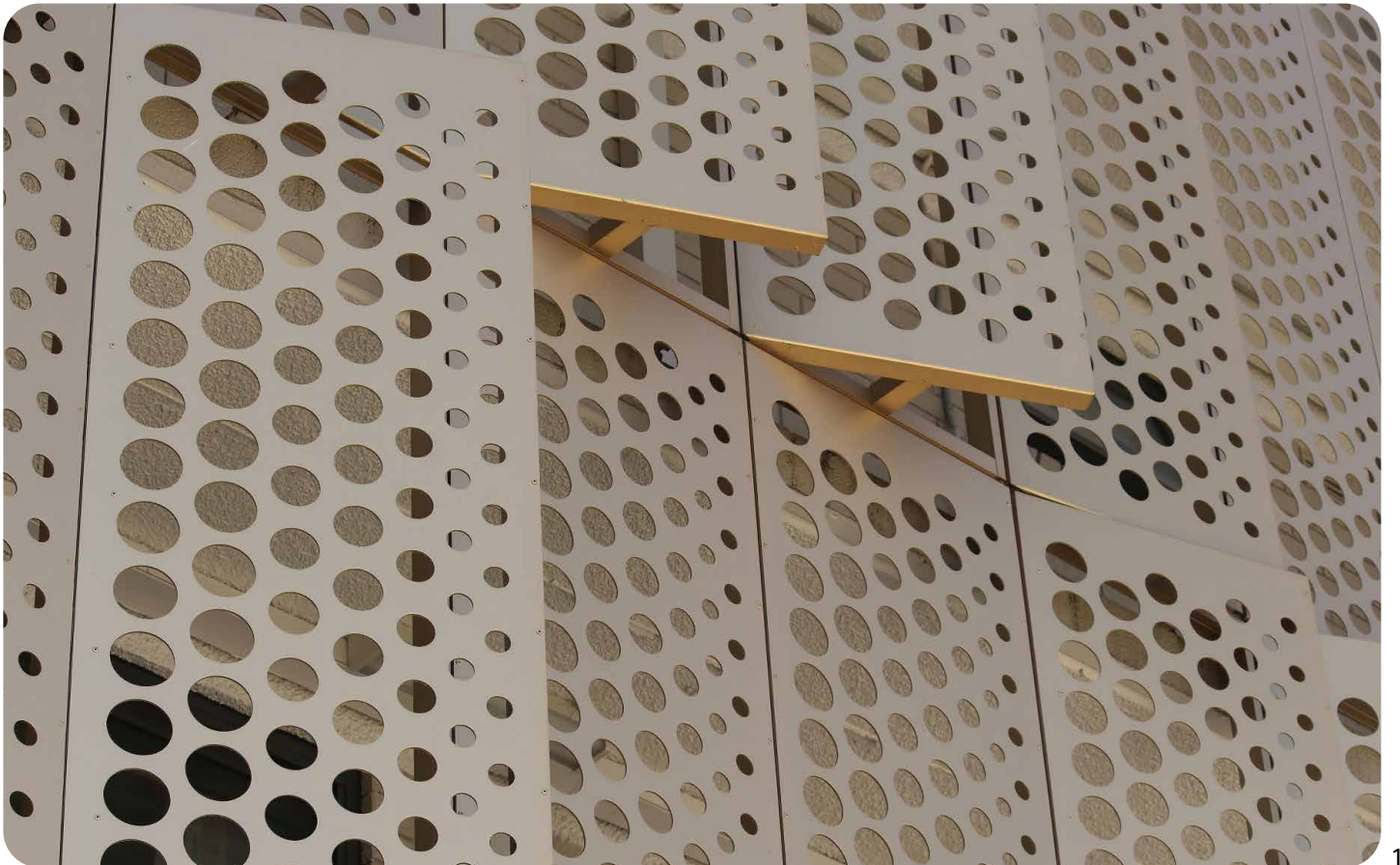
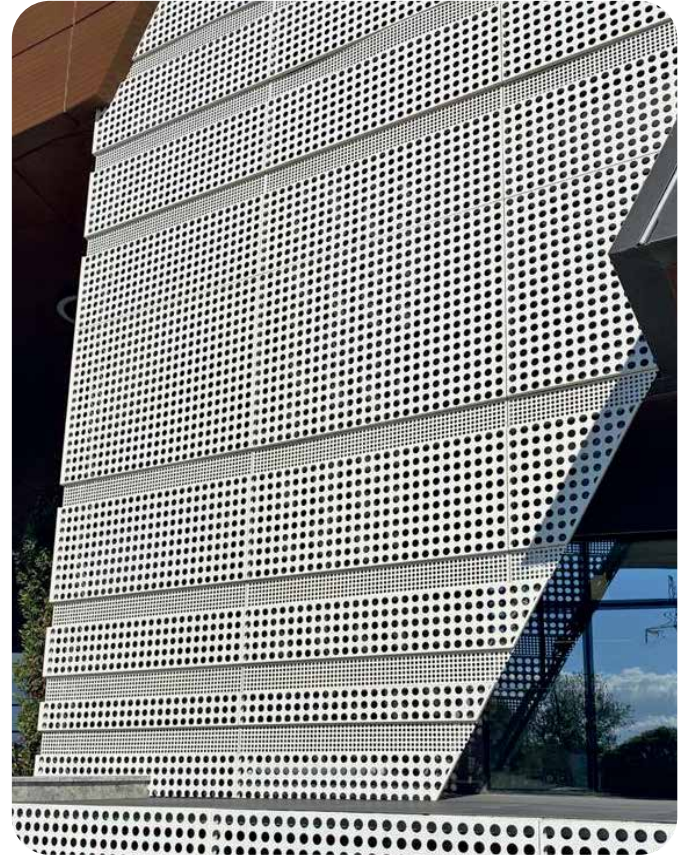



2001

1.0 mm
□ 25x25 mm
1000 mm



2002

1.0 mm
□ 30x30 mm
1000 mm



2003

1.2 mm
□ 40x40 mm
1000 mm



2004

1.2 mm
□ 47x47 mm
1200 mm



2005

1.5 mm
□ 60x60 mm
1200 mm



2006

2.0 mm
□ 70x70 mm
1200 mm



2007

2.0 mm
□ 80x80 mm
1200 mm

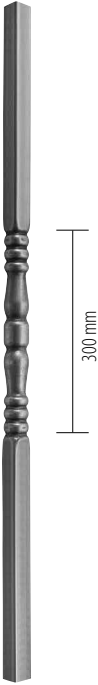

2009

1.0 mm
□ 25x25 mm
1000 mm



2010

1.0 mm
□ 30x30 mm
1000 mm



2011

1.2 mm
□ 40x40 mm
1000 mm



2013

1 mm
□ 25x25 mm
1000 mm



2014

1 mm
□ 30x30 mm
1000 mm

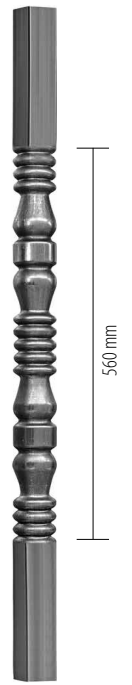

2015

1.2 mm
□ 40x40 mm
1000 mm



2016

1.0 mm
Ø 28 mm
1000 mm



2017

1.0 mm
Ø 32 mm
1000 mm



2018

1.0 mm
Ø 38 mm
1000 mm



2019

1.2 mm
Ø 42 mm
1000 mm

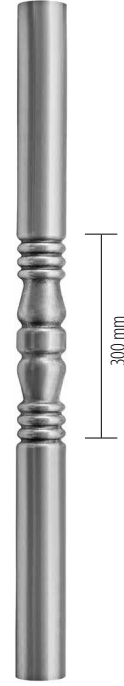

2020

1.2 mm
Ø 48 mm
1000 mm

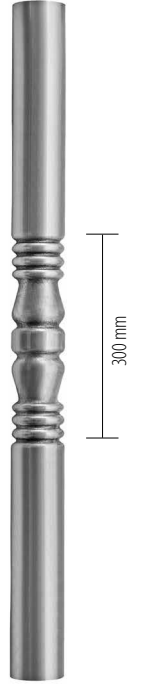

2021

1.2 mm
Ø 51 mm
1000 mm

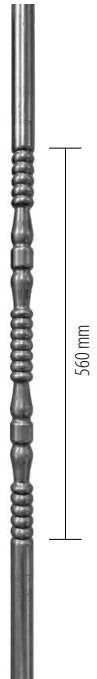

2022

1.0 mm
Ø 28 mm
1000 mm



2023

1.0 mm
Ø 32 mm
1000 mm



2024

1.0 mm
Ø 38 mm
1000 mm



2025

1.2 mm
Ø 42 mm
1000 mm



2026

1.2 mm
Ø 48 mm
1000 mm

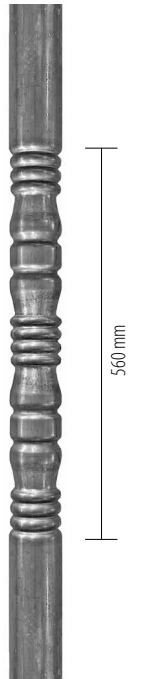

2027

1.2 mm
Ø 51 mm
1000 mm

Ø15 mm



130 mm

Ø15 mm

2028

1.2 mm
Ø 32 mm
900 mm

Ø15 mm



160 mm

Ø15 mm

2031

1.2 mm
Ø 32 mm
900 mm



Ø15 mm



160 mm

Ø15 mm

2044

1.2 mm
Ø 32 mm
900 mm

Ø15 mm



300 mm

Ø15 mm

2045

1.2 mm
Ø 32 mm
900 mm



130 mm

2030

1.2 mm
□ 25x25 mm
900 mm



160 mm

2033

1.2 mm
□ 25x25 mm
900 mm

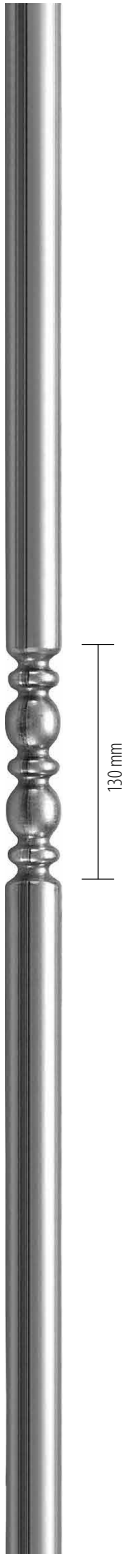

2029
1.2 mm
Ø 32 mm
900 mm

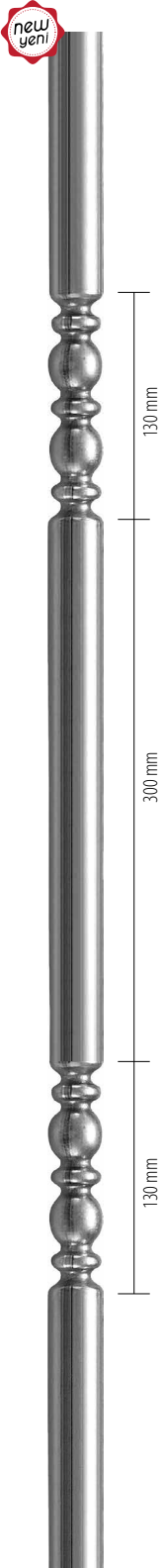

2029-A
1.2 mm
Ø 32 mm
900 mm

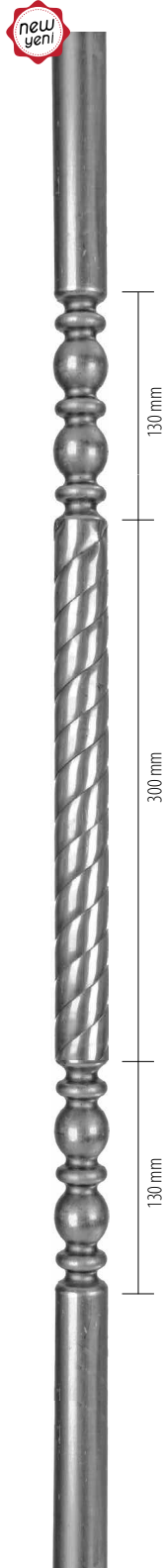

2029-B
1.2 mm
Ø 32 mm
900 mm

(YUVARLAK / ROUND)



2032
1.2 mm
Ø 32 mm
900 mm

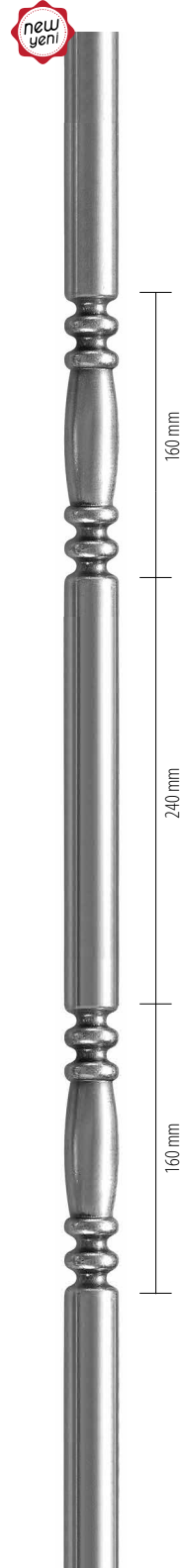

2032-A
1.2 mm
Ø 32 mm
900 mm

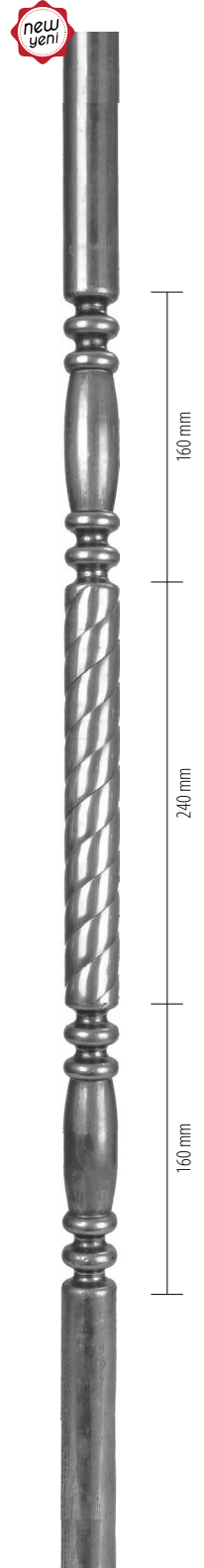

2032-B
1.2 mm
Ø 32 mm
900 mm

(YUVARLAK / ROUND)



2034
1.0 mm
Ø 28 mm
3000 mm



2035
1.0 mm
Ø 32 mm
3000 mm



2036
1.0 mm
Ø 38 mm
3000 mm



2037
1.2 mm
Ø 42 mm
3000 mm



2038
1.2 mm
Ø 48 mm
3000 mm



2039
1.2 mm
Ø 51 mm
3000 mm



2040
1.2 mm
Ø 60 mm
3000 mm



2041
1.5 mm
Ø 76 mm
3000 mm



2042
2.0 mm
Ø 89 mm
3000 mm



2043
2.0 mm
Ø 102 mm
3000 mm

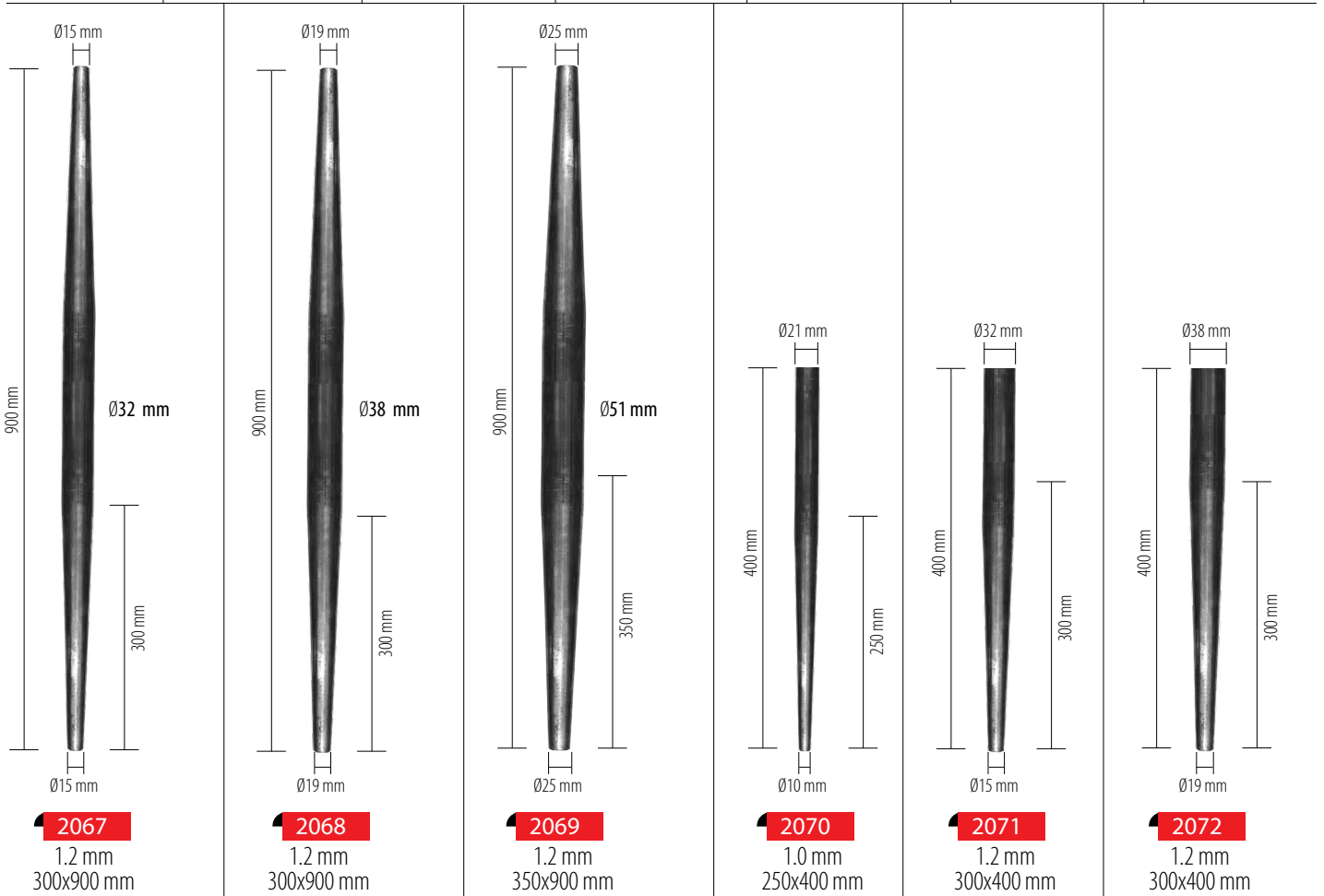
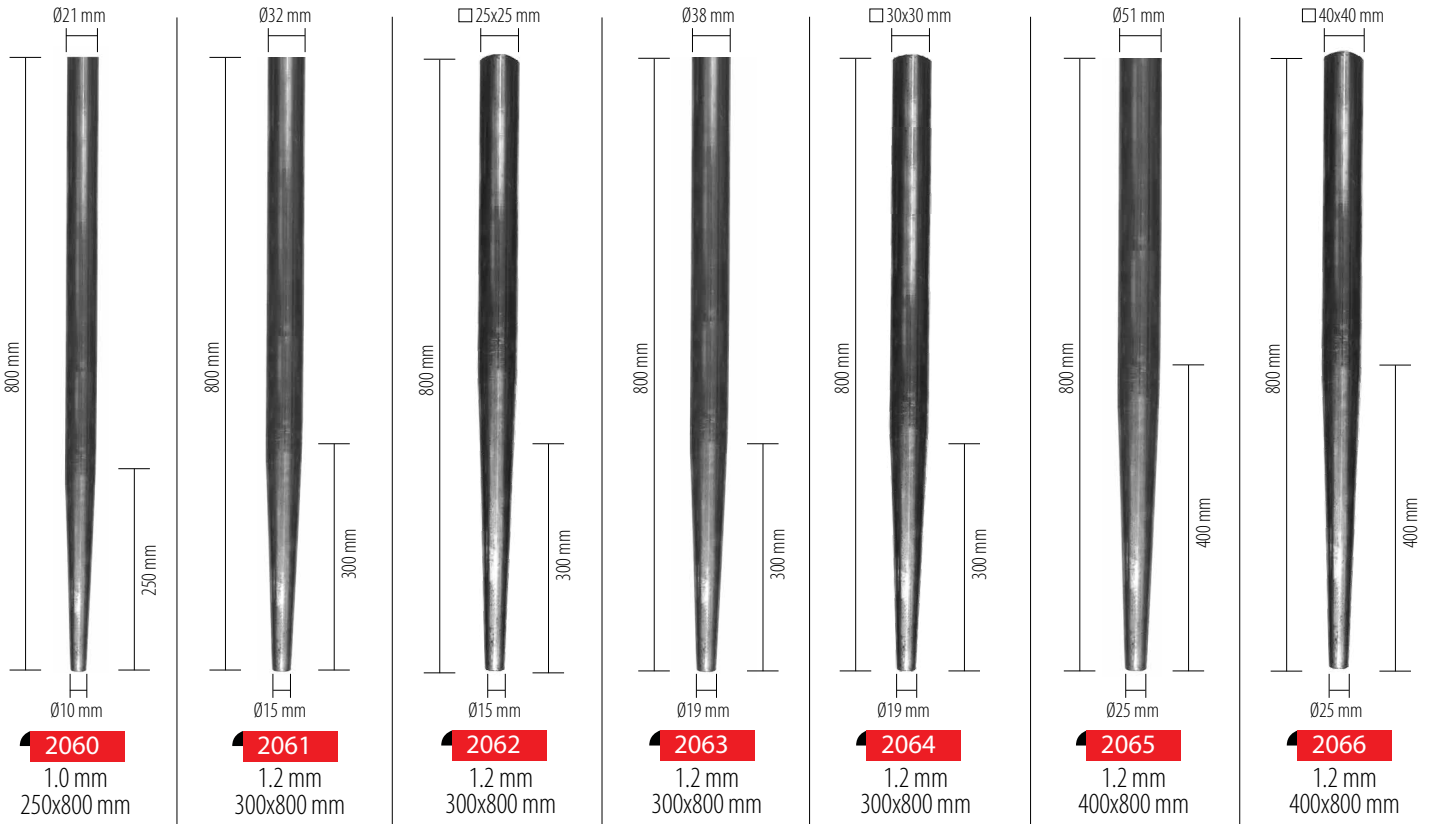



3 yönlü-3 sides

2050

2 mm

□ 60mm 1200 mm



3 yönlü-3 sides

2051

2 mm

□ 80mm 1200 mm



3 yönlü-3 sides

2052

2 mm

□ 100mm 1200 mm



2 yönlü-2 sides

2053

2 mm

□ 60mm 1200 mm



2 yönlü-2 sides

2054

2 mm

□ 80mm 1200 mm



2 yönlü-2 sides

2055

2 mm

□ 100mm 1200 mm



3 yönlü-3 sides

2050-A

2 mm

□ 60mm 1200 mm



3 yönlü-3 sides

2051-A

2 mm

□ 80mm 1200 mm

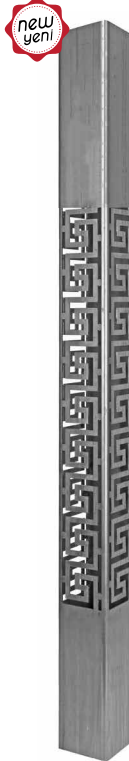

3 yönlü-3 sides

2052-A

2 mm

□ 100mm 1200 mm



2 yönlü-2 sides

2053-A

2 mm

□ 60mm 1200 mm

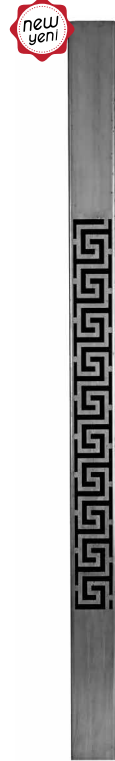

2 yönlü-2 sides

2054-A

2 mm

□ 80mm 1200 mm



2 yönlü-2 sides

2055-A

2 mm

□ 100mm 1200 mm

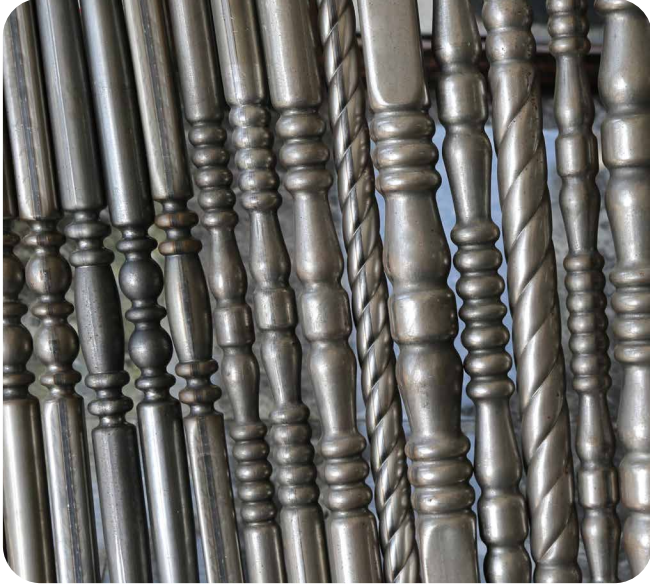

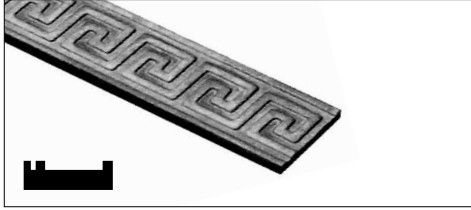
Dekoratif Desenli Lamalar- Decorative Patterned Flat Bars

Kod Code	Ölçü Dimension	Uzunluk Length	Ağırlık Weight
2202	30x5 mm	6000 mm	5.76 kg
2203	40x5 mm	6000 mm	8.12 kg
2204	30x8 mm	6000 mm	11.30 kg
2205	40x8 mm	6000 mm	15.00 kg



Kod Code	Ölçü Dimension	Uzunluk Length	Ağırlık Weight
2222	30x5 mm	6000 mm	5.76 kg
2223	40x5 mm	6000 mm	8.12 kg
2224	30x8 mm	6000 mm	11.30 kg
2225	40x8 mm	6000 mm	15.00 kg

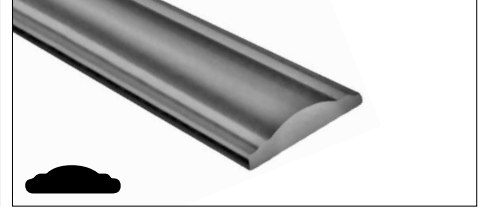

Kod Code	Ölçü Dimension	Uzunluk Length	Ağırlık Weight
2231	40x11 mm	6000 mm	15.00 kg
2232	50x14 mm	6000 mm	22.86 kg

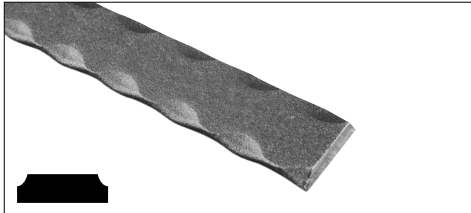

Kod Code	Ölçü Dimension	Uzunluk Length	Ağırlık Weight
2217	20x10 mm	6000 mm	9.42 kg
2218	25x10 mm	6000 mm	11.79 kg
2219	30x10 mm	6000 mm	14.16 kg
2220	40x10 mm	6000 mm	18.84 kg
2229	50x10 mm	6000 mm	23.58 kg

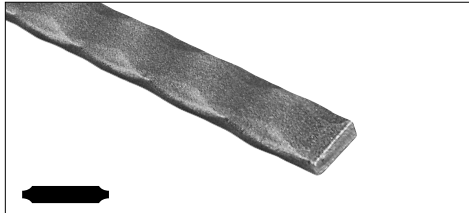

Kod Code	Ölçü Dimension	Uzunluk Length	Ağırlık Weight
2268	12x6 mm	6000 mm	3.40 kg
2269	14x6 mm	6000 mm	3.96 kg
2270	16x6 mm	6000 mm	4.52 kg
2271	16x7 mm	6000 mm	6.02 kg

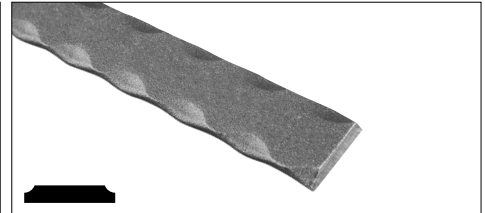

Kod Code	Ölçü Dimension	Uzunluk Length	Ağırlık Weight
2279	20x5 mm	6000 mm	4.70 kg
2280	25x5 mm	6000 mm	5.88 kg
2281	30x5 mm	6000 mm	7.08 kg
2282	40x5 mm	6000 mm	9.42 kg
2283	50x5 mm	6000 mm	11.79 kg

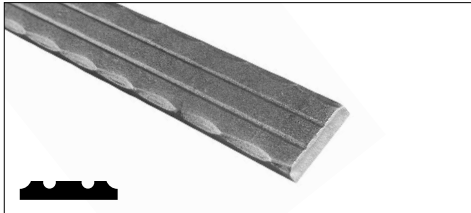

Kod Code	Ölçü Dimension	Uzunluk Length	Ağırlık Weight
2272	25x5 mm	6000 mm	5.89 kg
2273	30x5 mm	6000 mm	7.08 kg
2274	40x5 mm	6000 mm	9.42 kg
2275	50x5 mm	6000 mm	11.79 kg

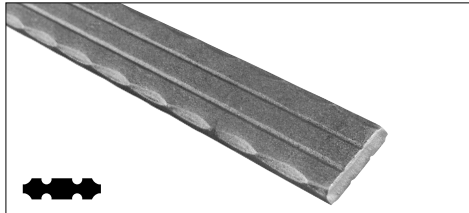

Kod Code	Ölçü Dimension	Uzunluk Length	Ağırlık Weight
2276	25x10 mm	6000 mm	11.79 kg
2277	30x10 mm	6000 mm	14.16 kg
2278	40x10 mm	6000 mm	18.84 kg

Dekoratif Kareler & Lamalar- Decorative Squares & Flat Bars

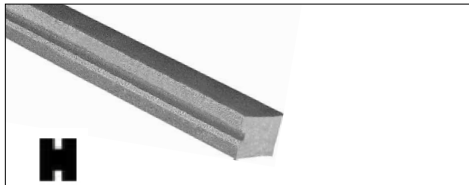

Kod Code	Ölçü Dimension	Uzunluk Length	Ağırlık Weight
2284	12x6 mm	6000 mm	3.40 kg
2285	14x6 mm	6000 mm	3.96 kg
2286	16x6 mm	6000 mm	4.52 kg
2287	16x7 mm	6000 mm	6.02 kg

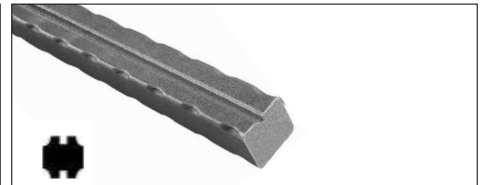

Kod Code	Ölçü Dimension	Uzunluk Length	Ağırlık Weight
2288	12x12 mm	6000 mm	6.78 kg
2289	14x14 mm	6000 mm	9.24 kg
2290	16x16 mm	6000 mm	12.06 kg

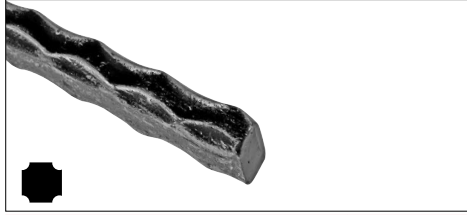

Kod Code	Ölçü Dimension	Uzunluk Length	Ağırlık Weight
2291	12x12 mm	6000 mm	6.78 kg



Kod Code	Ölçü Dimension	Uzunluk Length	Ağırlık Weight
2200-A	10x10 mm	6000 mm	4.71 kg
2200-B	12x12 mm	6000 mm	6.78 kg

Kod Code	Ölçü Dimension	Uzunluk Length	Ağırlık Weight
2211-B	10x10 mm	6000 mm	4.71 kg
2211-A	11x11 mm	6000 mm	5.69 kg
2211	12x12 mm	6000 mm	6.78 kg
2212	14x14 mm	6000 mm	9.24 kg
2213	16x16 mm	6000 mm	12.06 kg
2214	20x20 mm	6000 mm	18.84 kg

T-Z-L Profiller - T-Z-L Shaped Profiles

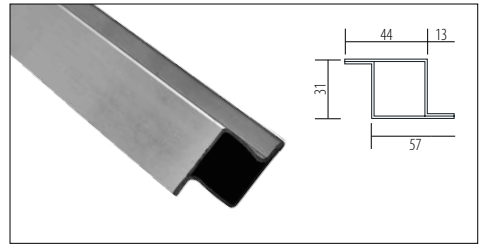
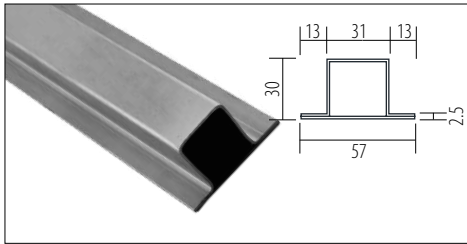
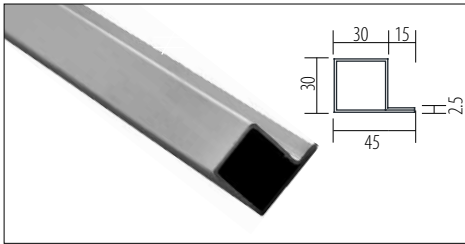

Kod Code	Ölçü Dimension	Uzunluk Length	Ağırlık Weight
2300	30x45x30 mm	6000 mm	9.50 kg

Kod Code	Ölçü Dimension	Uzunluk Length	Ağırlık Weight
2302	30x57x31 mm	6000 mm	11.00 kg

Kod Code	Ölçü Dimension	Uzunluk Length	Ağırlık Weight
2304	31x44x30 mm	6000 mm	11.00 kg

Delikli Lamalar - Punched Flat Bars

new
yeni

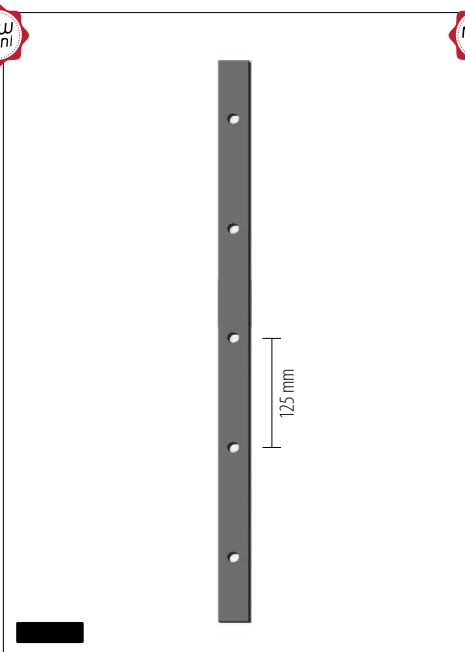

new
yeni

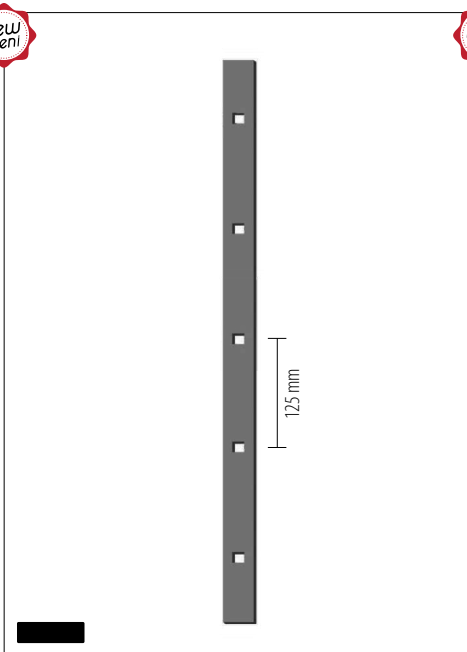

new
yeni

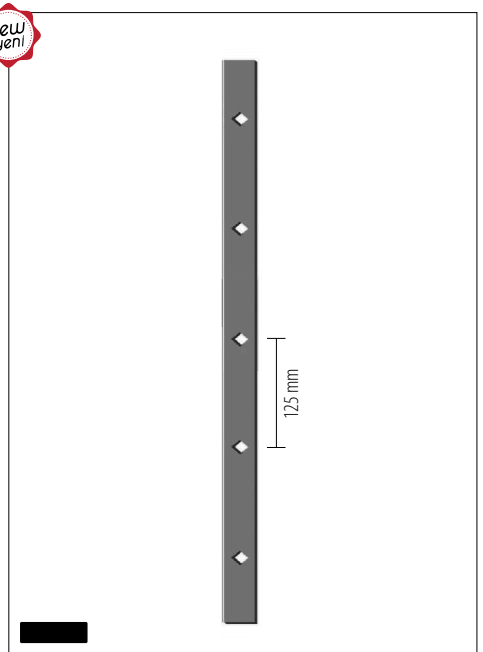

Kod Code	Ölçü Dimension	Delik Ölçüsü Hole Size	Ağırlık Weight
2310	30x10x2000 mm	Ø12 mm	4,53 kg
2311	30x10x2000 mm	Ø14 mm	4,46 kg
2312	30x10x2000 mm	Ø16 mm	4,39 kg

Kod Code	Ölçü Dimension	Delik Ölçüsü Hole Size	Ağırlık Weight
2313	30x10x2000 mm	12x12 mm	4,53 kg
2314	30x10x2000 mm	14x14 mm	4,46 kg
2315	30x10x2000 mm	16x16 mm	4,39 kg

Kod Code	Ölçü Dimension	Delik Ölçüsü Hole Size	Ağırlık Weight
2316	30x10x2000 mm	12x12 mm	4,53 kg
2317	30x10x2000 mm	14x14 mm	4,46 kg
2318	30x10x2000 mm	16x16 mm	4,39 kg

Dekoratif Profiller- Decorative Profiles

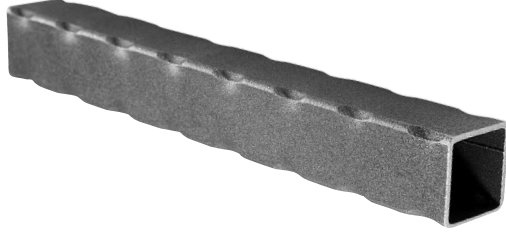

Kod Code	Ölçü Dimension	Uzunluk Length	Ağırlık Weight
2233	15x15x1.5 mm	6000 mm	3.60 kg
2234-A	20x20x1.5 mm	6000 mm	4.75 kg
2234	20x20x2 mm	6000 mm	6.00 kg
2235	25x25x1.5 mm	6000 mm	6.00 kg
2235-A	25x25x2 mm	6000 mm	7.50 kg
2236-A	30x30x1.5mm	6000 mm	7.35 kg
2236	30x30x2 mm	6000 mm	9.50 kg
2237	40x40x2 mm	6000 mm	12.50 kg
2238	50x50x2 mm	6000 mm	15.60 kg
2239	60x60x2 mm	6000 mm	19.35 kg

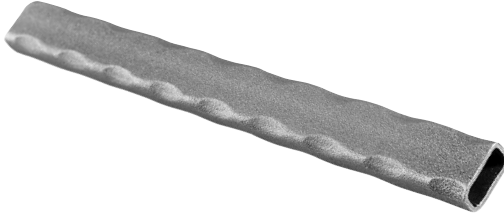

Kod Code	Ölçü Dimension	Uzunluk Length	Ağırlık Weight
2246	10x20x1.5 mm	6000 mm	3.60 kg
2247-A	20x30x1.5 mm	6000 mm	6.00 kg
2247	20x30x2 mm	6000 mm	7.50 kg
2248	20x40x2 mm	6000 mm	9.50 kg
2249	30x40x2 mm	6000 mm	11.05 kg
2250	30x50x2 mm	6000 mm	12.50 kg
2252	40x60x2 mm	6000 mm	15.60 kg
2253	40x80x2 mm	6000 mm	19.35 kg



Kod Code	Ölçü Dimension	Uzunluk Length	Ağırlık Weight
2390	15x15x1.5 mm	6000 mm	4.75 kg
2260-A	20x20x1.5 mm	6000 mm	4.75 kg
2391	20x20x2 mm	6000 mm	6.00 kg
2260-B	25x25x1.5 mm	6000 mm	6.00 kg
2392	25x25x2 mm	6000 mm	7.50 kg
2393	30x30x1.5 mm	6000 mm	7.35 kg
2260	30x30x2 mm	6000 mm	9.50 kg
2261	40x40x2 mm	6000 mm	12.50 kg
2261-A	50x50x2 mm	6000 mm	15.60 kg
2261-B	60x60x2 mm	6000 mm	19.35 kg



Kod Code	Ölçü Dimension	Uzunluk Length	Ağırlık Weight
2240-A	10x30x1.5 mm	6000 mm	4.75 kg
2240	20x30x2 mm	6000 mm	7.50 kg
2241	20x40x2 mm	6000 mm	9.50 kg
2242	30x40x2 mm	6000 mm	11.05 kg
2243	40x60x2 mm	6000 mm	15.60 kg
2243-A	40x80x2 mm	6000 mm	19.38 kg



Kod Code	Ölçü Dimension	Uzunluk Length	Ağırlık Weight
2295	Ø32x1.5 mm	6000 mm	6.00 kg
2296	Ø38x1.5 mm	6000 mm	7.30 kg
2297	Ø51x1.5 mm	6000 mm	9.40 kg
2298	Ø60x1.5 mm	6000 mm	11.70 kg

Kod Code	Ölçü Dimension	Uzunluk Length	Ağırlık Weight
2293	30x30x2 mm	6000 mm	9.50 kg
2294	40x40x2 mm	6000 mm	12.50 kg



Dekoratif Küpeştelere - Decorative Handrails

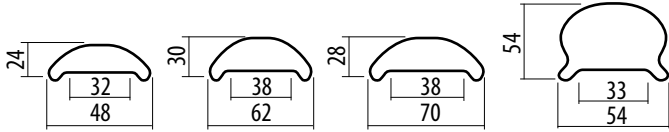

Kod Code	Ölçü Dimension	Uzunluk Length	Ağırlık Weight
2254	24x48x1.5 mm	6000 mm	7.32 kg
2255	30x62x1.5 mm	6000 mm	9.50 kg
2292	28x70x1.5 mm	6000 mm	11.90 kg
2244	54x54x1.5 mm	6000 mm	12.20 kg

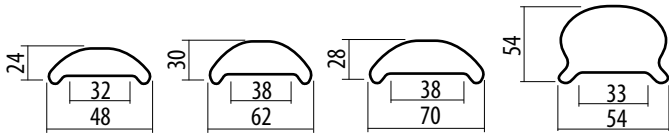
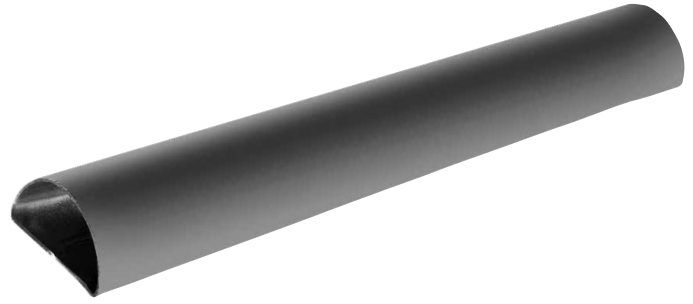

Kod Code	Ölçü Dimension	Uzunluk Length	Ağırlık Weight
2257	24x48x1.5 mm	6000 mm	7.32 kg
2258	30x62x1.5 mm	6000 mm	9.50 kg
2264	28x70x1.5 mm	6000 mm	11.90 kg
2245	54x54x1.5 mm	6000 mm	12.20 kg

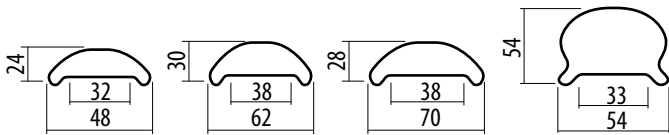

Kod Code	Ölçü Dimension	Uzunluk Length	Ağırlık Weight
2262	24x48x1.5 mm	6000 mm	7.32 kg
2263	30x62x1.5 mm	6000 mm	9.50 kg
2259	28x70x1.5 mm	6000 mm	11.90 kg
2256	54x54x1.5 mm	6000 mm	12.20 kg

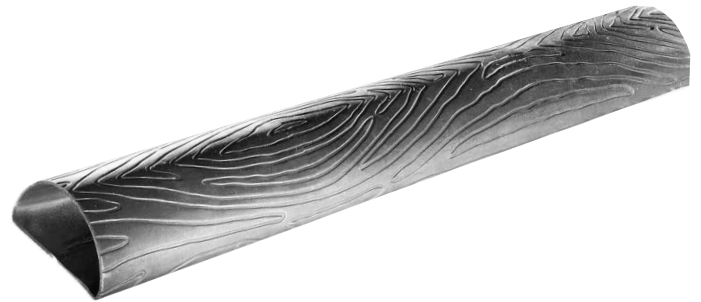

Alüminyum Kapaklar - Aluminium Lids



2265
45x20x40 mm
0.060 kg



2266
60x30x50 mm
0.100 kg



2267
54x54x36 mm
0.120 kg



2350
□ 14 mm
75x400 mm
900 mm



2351
□ 14 mm
75x240 mm
900 mm



2352
□ 14 mm
75x350 mm
900 mm

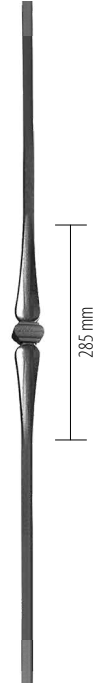

2353
□ 14 mm
38x285 mm 900 mm
düz (smooth)



2354
□ 14 mm
38x650 mm 900 mm
düz (smooth)



2355
Ø 14 mm
40x285 mm
900 mm



2356
Ø 14 mm
40x650 mm
900 mm



2357
□ 12 mm
80x410 mm
900 mm



2358
□ 12 mm
38x285 mm 900 mm
izli (hammered)



2359
□ 12 mm
38x680 mm 900 mm
izli (hammered)



2360
□ 12 mm
30x340 mm
900 mm

2360-A
□ 14 mm
30x340 mm
900 mm

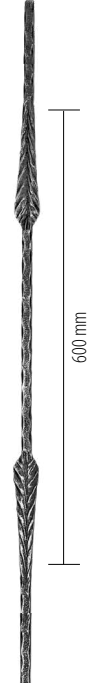

2361
□ 12 mm
30x600 mm
900 mm

2361-A
□ 14 mm
30x600 mm
900 mm



2362
□ 12 mm
900 mm



2363
□ 12 mm
900 mm



2364
□ 12 mm
900 mm



2365
□ 12 mm
900 mm



2366
□ 12 mm
36x270 mm
900 mm



2367
□ 12 mm
30x480 mm
900 mm



2368
□ 12 mm
32x90 mm
900 mm



2369
□ 12 mm
32x480 mm
900 mm



2370
□ 12 mm
27x155 mm
900 mm



2371
□ 12 mm
27x550 mm
900 mm



2372
□ 12 mm
30x170 mm
900 mm



2373
□ 12 mm
23x160 mm
900 mm



2374
□ 12 mm
25x155 mm
900 mm



2375
□ 12 mm
25x530 mm
900 mm



2376
□ 12 mm
55x200 mm
900 mm



2377
□ 12 mm
55x600 mm
900 mm



2378
□ 12 mm
61x200 mm
900 mm



2379
□ 12 mm
61x600 mm
900 mm

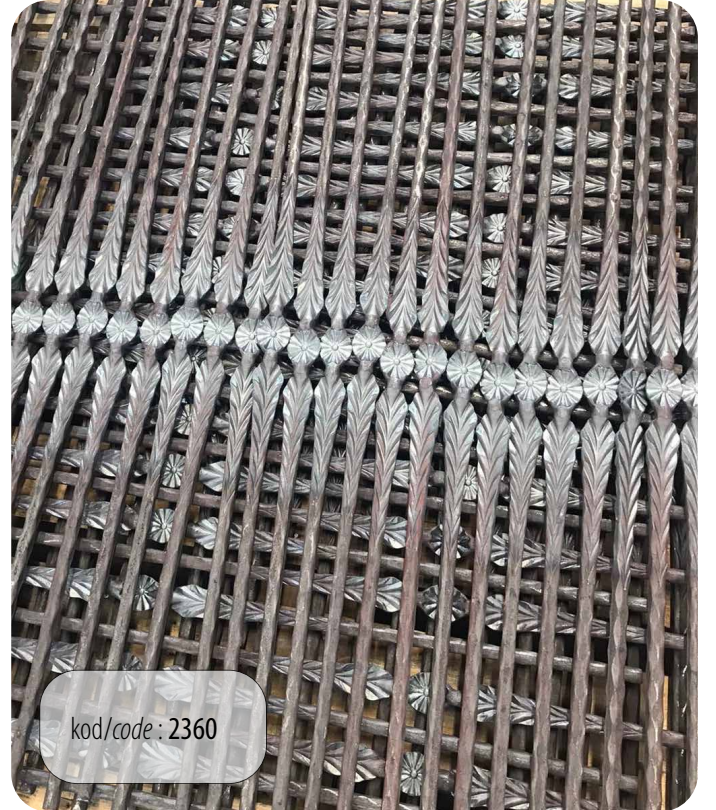
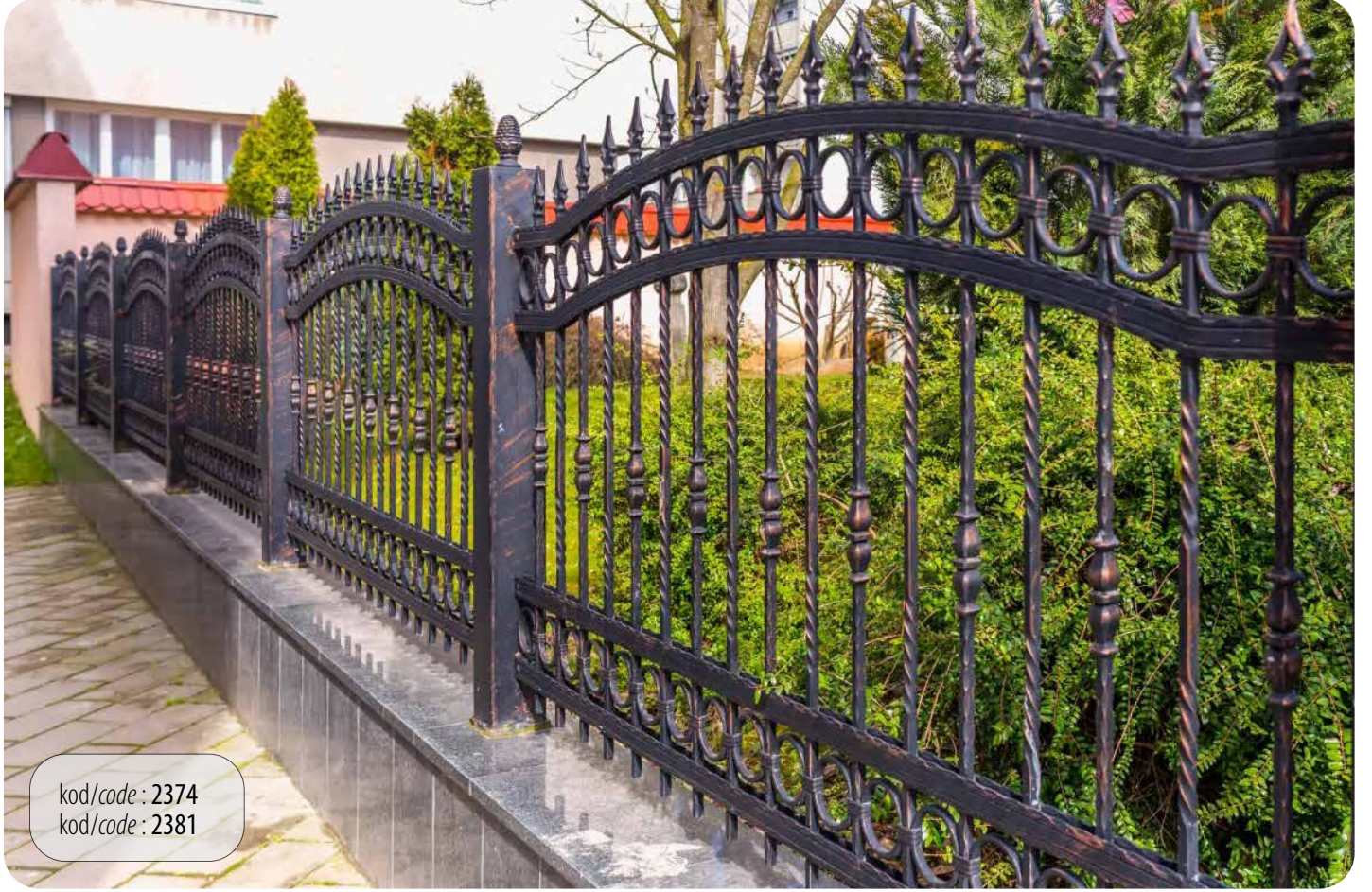



2380

□ 12 mm
800 mm



2381

□ 12 mm
800 mm



2382

□ 12 mm
800 mm

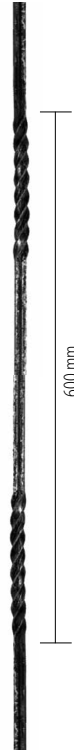

2383

□ 12 mm
800 mm



2384

□ 12 mm
800 mm



2385

□ 16x7 mm
800 mm

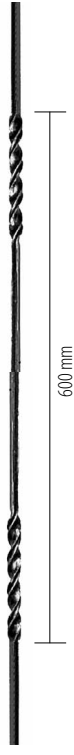

2386

□ 16x7 mm
800 mm



2420

□ 12 mm
95x340 mm
800 mm

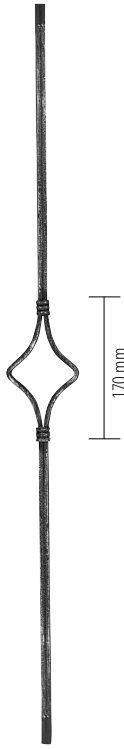

2421

□ 12 mm
95x170 mm
800 mm

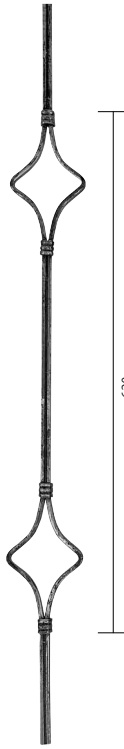

2422

□ 12 mm
95x620 mm
800 mm

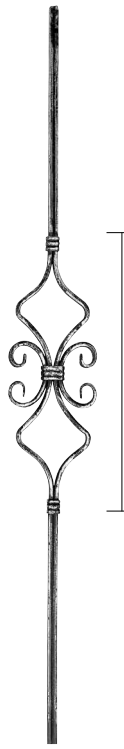

2423

□ 12 mm
115x335 mm
800 mm



2424

□ 12 mm
170x420 mm
800 mm



2425

□ 16x7 mm
120x800 mm

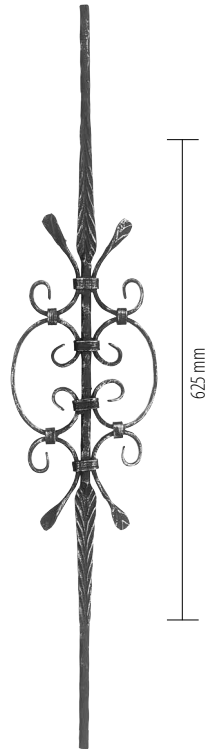

2426

□ 12 mm
180x625 mm
800 mm



620 mm

2427

□ 16 mm
110x620 mm
800 mm

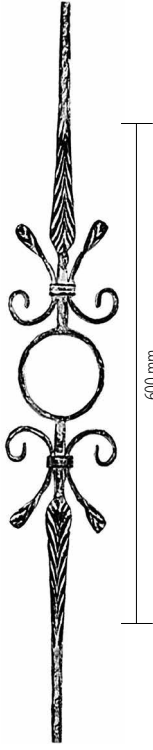

600 mm

2428

□ 12 mm
140x600 mm
800 mm

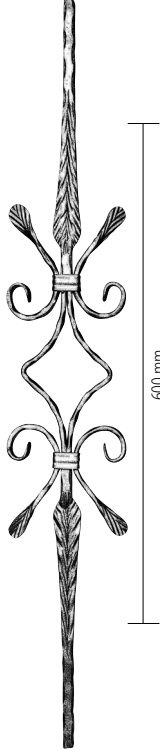

600 mm

2429

□ 12 mm
140x600 mm
800 mm

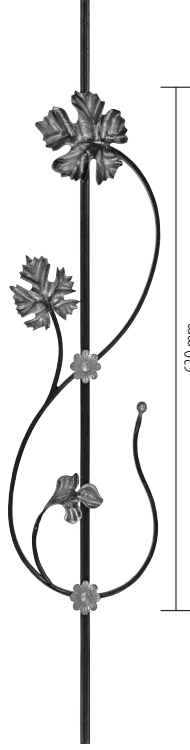

630 mm

2430

□ 12 mm
195x630 mm
800 mm

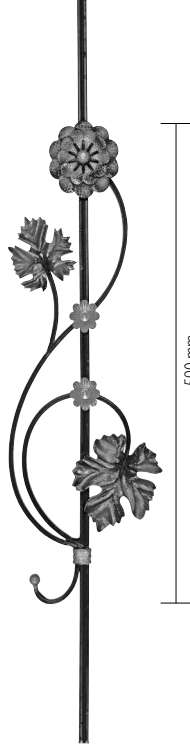

590 mm

2431

□ 12 mm
200x590 mm
800 mm

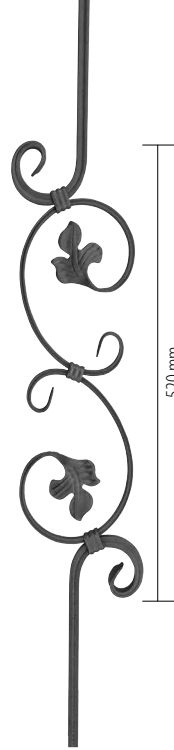

520 mm

2432

□ 12 mm
160x520 mm
800 mm



2433

□ 12x6 mm
175x800 mm

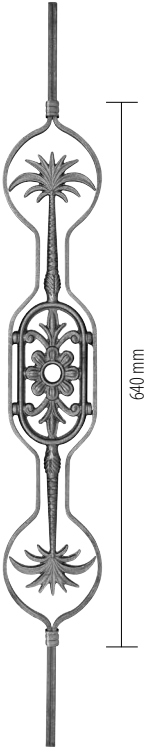

640 mm

2434

□ 12 mm
130x640 mm
800 mm



2435

□ 12 mm
160x800 mm



630 mm

2436

□ 12 mm
185x630 mm
800 mm

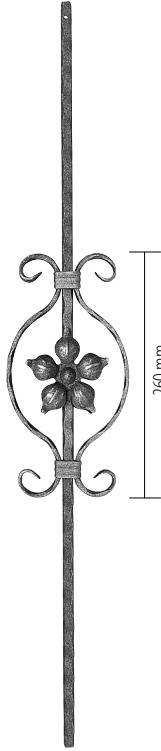

260 mm

2437

□ 12 mm
140x260 mm
800 mm

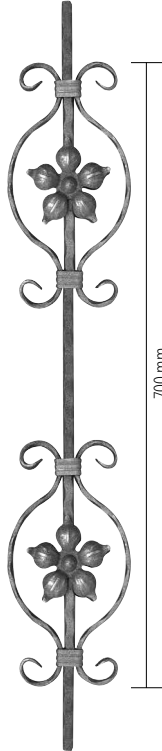

700 mm

2438

□ 12 mm
140x700 mm
800 mm

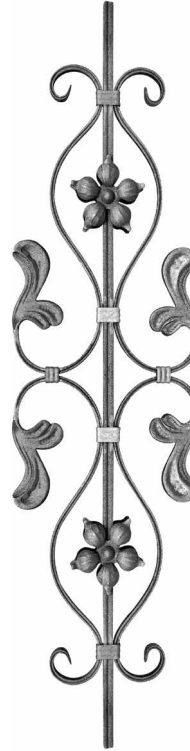

740 mm

2439

□ 12 mm
240x740 mm
800 mm

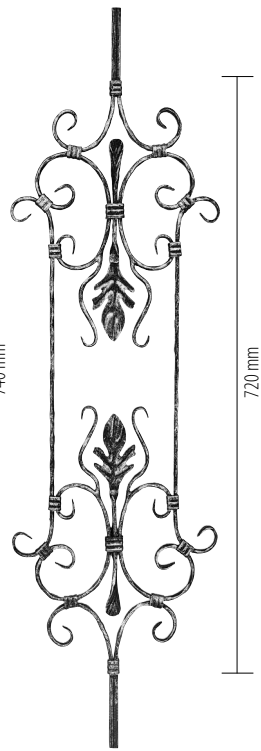

720 mm

2440

□ 12 mm
270x720 mm
900 mm

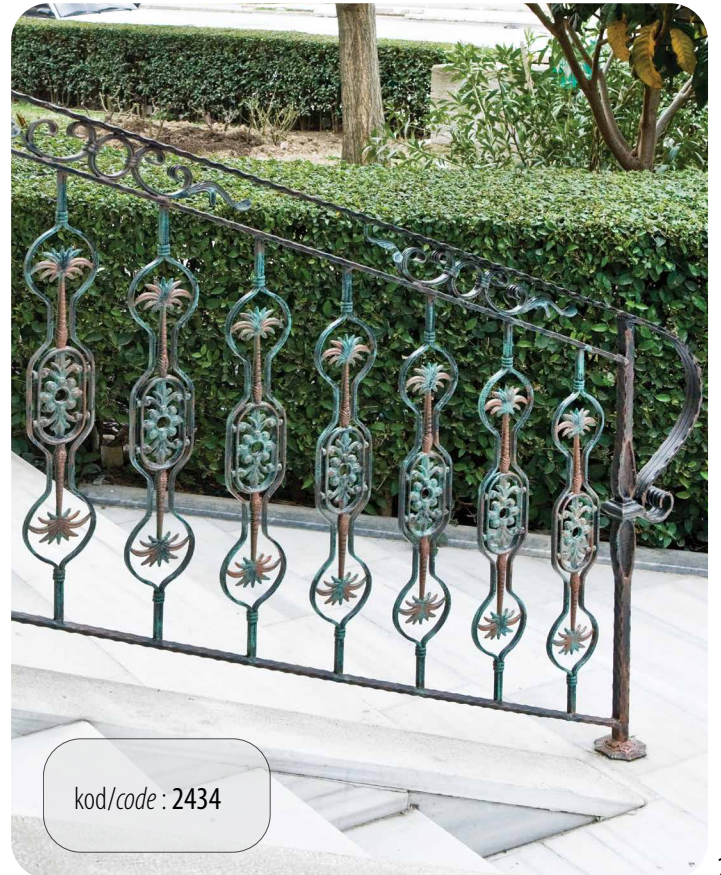
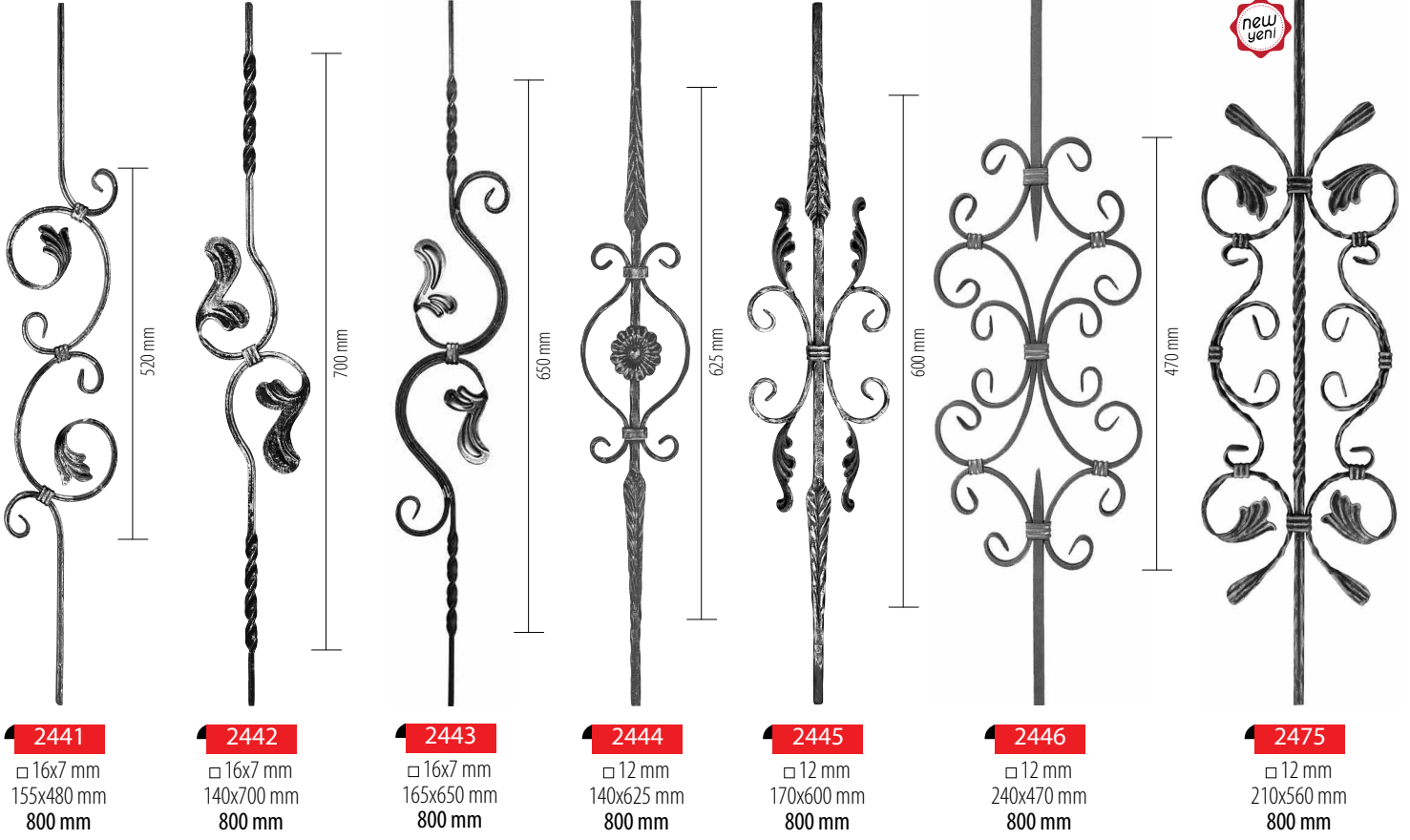



perçinli
(with rivet)



2447

□ 12 mm
140x510 mm
800 mm



perçinli
(with rivet)



2448

□ 12 mm
140x500 mm
800 mm



perçinli
(with rivet)



2449

□ 12 mm
145x570 mm
800 mm



2450

□ 12 mm
145x510 mm
800 mm



perçinli
(with rivet)



2451

□ 12 mm
185x590 mm
800 mm



2452

□ 12 mm
185x590 mm
800 mm



perçinli
(with rivet)



2453

□ 12 mm
180x280 mm
800 mm



2454

□ 12 mm
180x680 mm
800 mm



kod/code : 29203

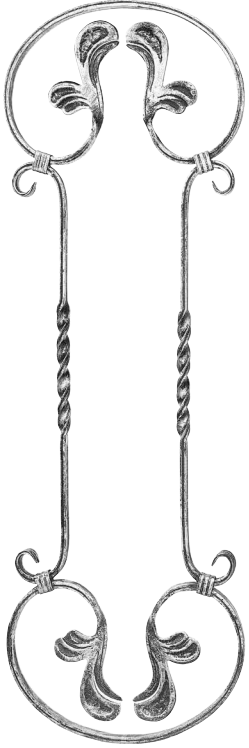

2468
□ 16x7 mm
275x800 mm
3,00 kg

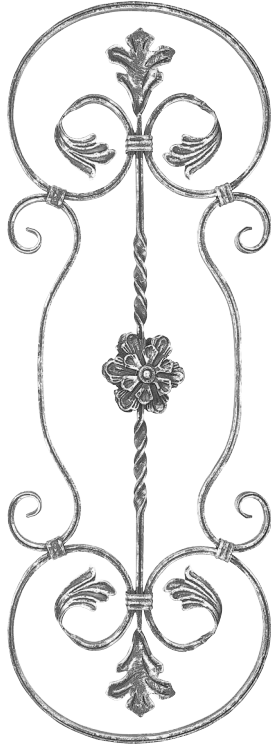

2469
□ 16x7 mm
290x800 mm
3,89 kg

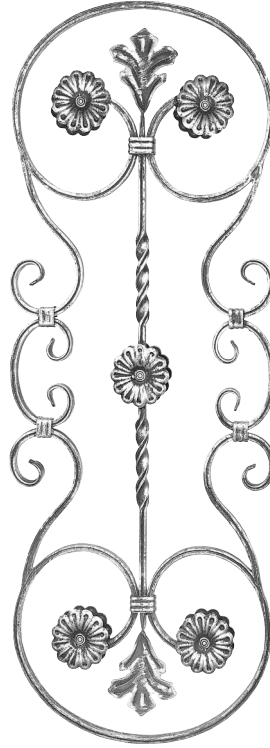

2470
□ 16x7 mm
290x800 mm
4,32 kg



2471
□ 12x6 mm
290x800 mm
2,66 kg

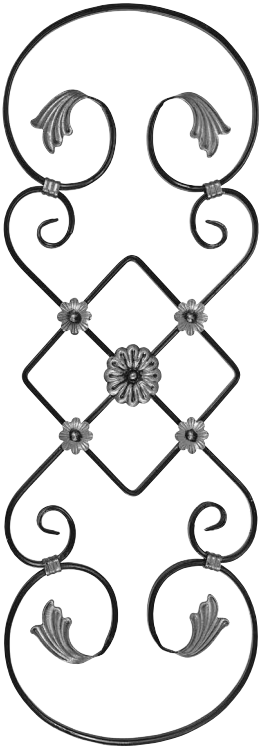

2472
□ 12x6 mm
300x800 mm
2,00 kg



2473
□ 16x7 mm
290x530 mm
2,91 kg



2474
□ 16x7 mm
290x530 mm
3,19 kg



kod/code : 2407

Motifli Cumba Çubuklar - Window & Balcony Balustrades



2400

□ 14 mm
170x600 mm
800 mm



2401

□ 14 mm
170x600 mm
800 mm



2402

□ 30x5 mm
140x570 mm
800 mm



2403

□ 30x5 mm
140x470 mm
800 mm



2404

□ 30x5 mm
140x570 mm
800 mm



2405

□ 12 mm
170x700 mm
800 mm



2406

□ 12 mm
170x700 mm
800 mm



2406-A

□ 12 mm
170x700 mm
800 mm



2407

□ 12 mm
170x600 mm
800 mm



2408

□ 30x5 mm
140x470 mm
800 mm



2411

□ 30x5 mm
120x730 mm
800 mm



2412

□ 12 mm
100x520 mm
800 mm



2413

□ 12 mm
170x700 mm
1250 mm



2414

□ 12 mm
170x380 mm
800 mm



2415

□ 12 mm
170x380 mm
800 mm



2416

□ 12 mm
100x520 mm
800 mm

Merdiven Başlangıç Çubukları - *Begining Bars of Stairs*



21100

□ 24 mm
1200 mm
6,10 kg



21104

□ 24 mm
1200 mm
5,70 kg



21105

□ 24 mm
1200 mm
6,20 kg



21108

□ 24 mm
1200 mm
5,70 kg



21109

□ 24 mm
1200 mm
5,15 kg



21110

□ 24 mm
1200 mm
5,60 kg



21123

□ 24 mm
1200 mm
5,80 kg



21127

□ 24 mm
1200 mm
5,55 kg



21129

□ 20 mm
1200 mm
3,55 kg

Merdiven Bağlantı Elemanları ve Kıvrımlar - *Stair Fitting and Bendings*



21130

□ 24 mm
1200 mm
5,60 kg



21131

□ 30 mm
1200 mm
8,40 kg



21132

□ 30 mm
1200 mm
12,85 kg



21302

□ 40x10 mm
200x300 mm
1,57 kg



21303

□ 40x10 mm
100x500 mm
1,99 kg



21304

□ 40x10 mm
100x150 mm
1,01 kg



21306

□ 40x10 mm
170x320 mm
1,77 kg



21117



□ 12 mm
95x180 mm







2476

Ø12 mm
70x115 mm

C Motifler - Ornamental Scrolls





	soğuk dövme cold forging	
	Kod Code	Ölçü Dimension
	22400	80x50 mm
	22401	100x60 mm
	22403	120x70 mm
	22406	130x75 mm
	22407	140x80 mm
	22408	150x75 mm
	22409	160x80 mm
	22410	220x130 mm
	22411	200x120 mm
	22412	250x130 mm
		Kod Code
22450		80x50 mm
22451		100x60 mm
22453		120x70 mm
22456		130x75 mm
22457		140x80 mm
22458		150x75 mm
22459		160x80 mm
22460		220x130 mm
22461		200x120 mm
22462		250x130 mm





	sıcak dövme hot forging	
	Kod Code	Ölçü Dimension
	22500	80x50 mm
	22501	100x60 mm
	22503	120x70 mm
	22506	130x75 mm
	22507	140x80 mm
	22508	150x75 mm
	22509	160x80 mm
	22510	220x130 mm
	22511	200x120 mm
	22512	250x130 mm
		Kod Code
22550		80x50 mm
22551		100x60 mm
22553		120x70 mm
22556		130x75 mm
22557		140x80 mm
22558		150x75 mm
22559		160x80 mm
22560		220x130 mm
22561		200x120 mm
22562		250x130 mm



			
Kod Code	Malzeme Material	Ölçü Dimension	Ağırlık Weight
22800	□ 12x6 mm soğuk dövme (cold forged)	60x120 mm	0.12 kg
22900	□ 12x6 mm sıcak dövme (hot forged)	60x120 mm	0.12 kg

			
Kod Code	Malzeme Material	Ölçü Dimension	Ağırlık Weight
22801	□ 12x6 mm soğuk dövme (cold forged)	60x120 mm	0.12 kg
22901	□ 12x6 mm sıcak dövme (hot forged)	60x120 mm	0.12 kg

			
Kod Code	Malzeme Material	Ölçü Dimension	Ağırlık Weight
22802	□ 12x6 mm soğuk dövme (cold forged)	100x150 mm	0.20 kg
22902	□ 12x6 mm sıcak dövme (hot forged)	100x150 mm	0.20 kg

				
23012	23018	23019	23022	23023
□ 12x6 mm 180x90 mm 0,21 kg	□ 12x6 mm 100x150 mm 0,20 kg	□ 12x6 mm 100x150 mm 0,20 kg	□ 12x6 mm 140x190 mm 0,25 kg	□ 12x6 mm 140x190 mm 0,25 kg

				
23013	23020	23021	23024	23025
□ 12x6 mm 220x120 mm 0,26 kg	□ 12x6 mm 135x190 mm 0,30 kg	□ 12x6 mm 135x190 mm 0,30 kg	□ 12x6 mm 135x190 mm 0,30 kg	□ 12x6 mm 135x190 mm 0,30 kg

	
23072	23073
□ 16x7 mm 210x320 mm 0,81 kg	□ 16x7 mm 210x320 mm 0,81 kg

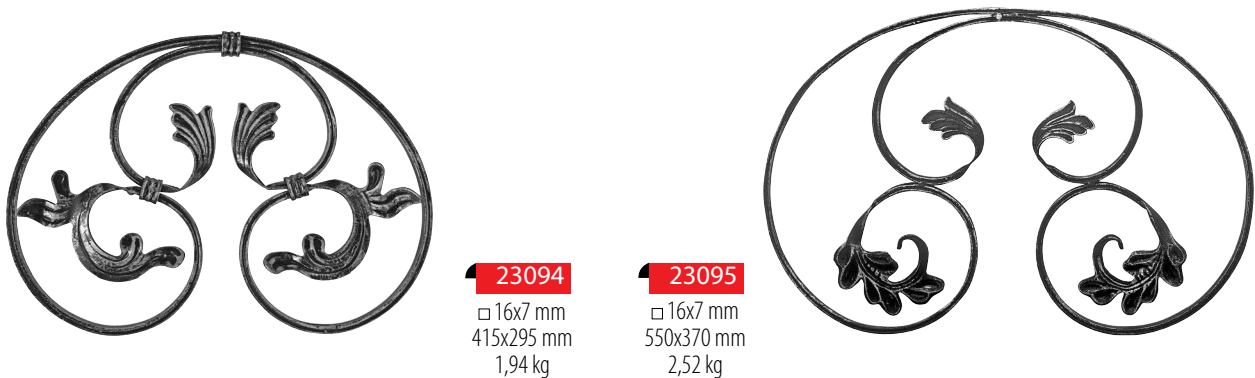
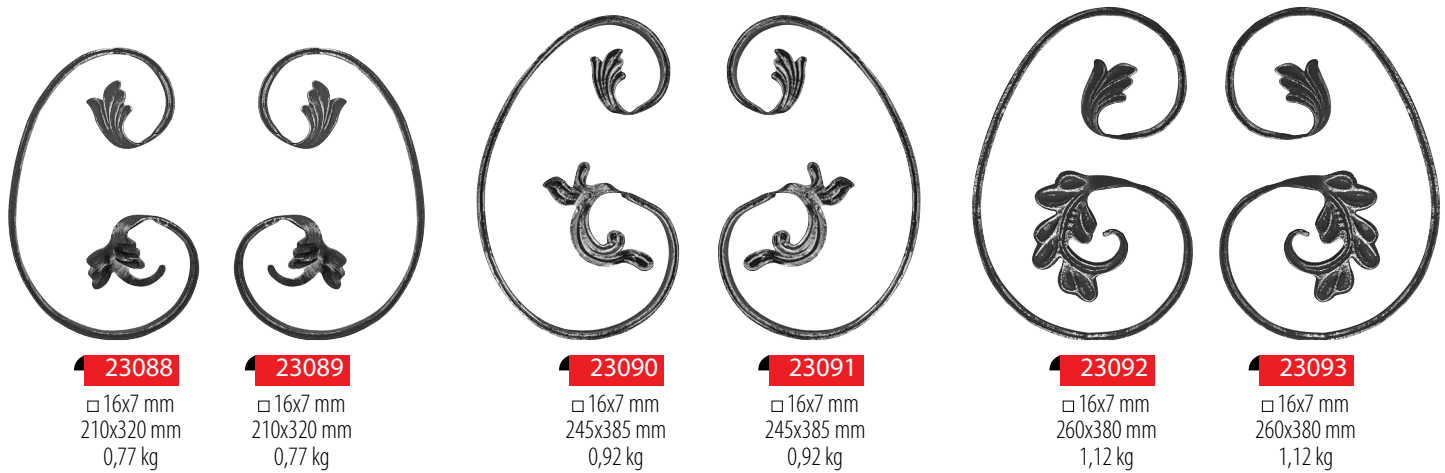
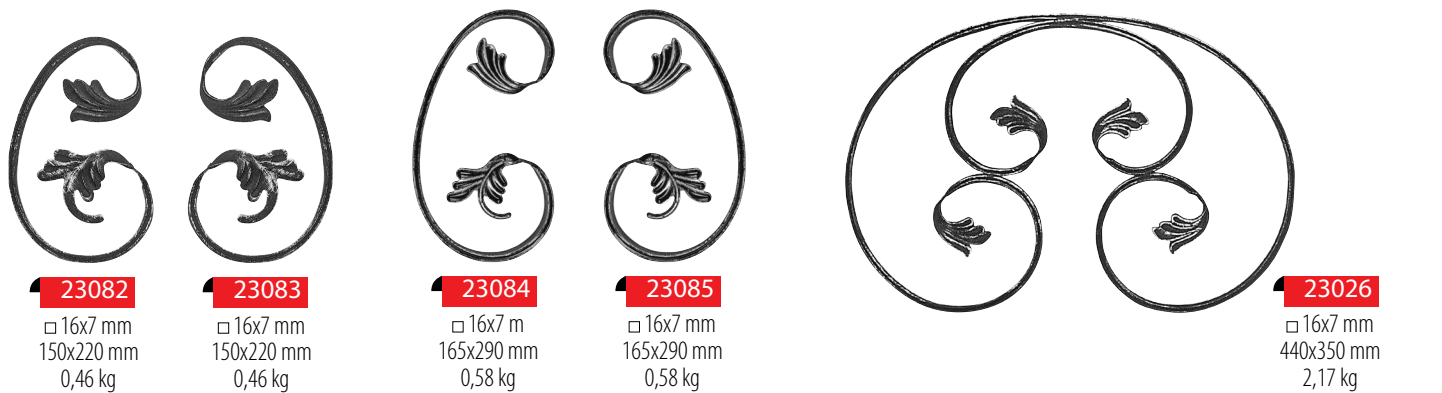

S Motifler - Ornamental Scrolls



□ 12x6 mm
izli / hammered
soğuk dövme / cold forging

Kod Code	Ölçü Dimension
22600	150x70 mm
22601	170x80 mm
22605	200x85 mm
22606	220x100 mm
22607	230x115 mm
22608	260x115 mm
22609	270x110 mm
22610	280x120 mm
22611	300x120 mm
22612	330x130 mm
22613	360x120 mm



□ 12x6 mm
izli / hammered
sıcak dövme / hot forging

Kod Code	Ölçü Dimension
22700	150x70 mm
22701	170x80 mm
22705	200x85 mm
22706	220x100 mm
22707	230x115 mm
22708	260x115 mm
22709	270x110 mm
22710	280x120 mm
22711	300x120 mm
22712	330x130 mm
22713	360x120 mm



□ 12x6 mm
düz / smooth
soğuk dövme / cold forging

Kod Code	Ölçü Dimension
22650	150x70 mm
22651	170x80 mm
22655	200x85 mm
22656	220x100 mm
22657	230x115 mm
22658	260x115 mm
22659	270x110 mm
22660	280x120 mm
22661	300x120 mm
22662	330x130 mm
22663	360x120 mm



□ 12x6 mm
düz / smooth
sıcak dövme / hot forging

Kod Code	Ölçü Dimension
22750	150x70 mm
22751	170x80 mm
22755	200x85 mm
22756	220x100 mm
22757	230x115 mm
22758	260x115 mm
22759	270x110 mm
22760	280x120 mm
22761	300x120 mm
22762	330x130 mm
22763	360x120 mm



Kod Code	Malzeme Material	Ölçü Dimension	Ağırlık Weight
22809	□ 12x6 mm soğuk dövme (cold forged)	75x260 mm	0.230 kg
22909	□ 12x6 mm sıcak dövme (hot forged)	75x260 mm	0.187 kg



Kod Code	Malzeme Material	Ölçü Dimension	Ağırlık Weight
22905	□ 12x6 mm sıcak dövme (hot forged)	60x260 mm	0.182 kg
22906	□ 12x6 mm sıcak dövme (hot forged)	80x380 mm	0.390 kg
22907	□ 12x6 mm sıcak dövme (hot forged)	90x420 mm	0.420 kg



Kod Code	Malzeme Material	Ölçü Dimension
31213	□ 12x12 mm	100x150 mm
31214	□ 14x14 mm	100x150 mm
31215	□ 16x16 mm	100x150 mm

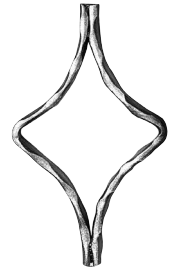

22815
□ 12x6 mm
100x185 mm
0,22 kg



23000 □ 12x6 mm 100x170 mm 0,20 kg	23001 □ 12x6 mm 100x170 mm 0,20 kg	23008 □ 12x6 mm 130x200 mm 0,26 kg	23009 □ 12x6 mm 130x200 mm 0,26 kg	23050 □ 12x6 mm 130x300 mm 0,58 kg	23051 □ 12x6 mm 130x300 mm 0,58 kg	23052 □ 12x6 mm 135x300 mm 0,59 kg	23053 □ 12x6 mm 135x300 mm 0,59 kg	23054 □ 12x6 mm 150x350 mm 0,61 kg	23055 □ 12x6 mm 150x350 mm 0,61 kg
--	--	--	--	--	--	--	--	--	--



23097
□ 12 mm
165x450 mm
0,96 kg



23002
□ 16x7 mm
140x400 mm
0,59 kg



23003
□ 16x7 mm
140x400 mm
0,59 kg



23056
□ 16x7 mm
210x410 mm
0,83 kg



23057
□ 16x7 mm
210x410 mm
0,83 kg



23058
□ 16x7 mm
210x410 mm
0,83kg



23059
□ 16x7 mm
210x410 mm
0,88 kg



29303
□ 12 mm
250x720 mm
2,15 kg

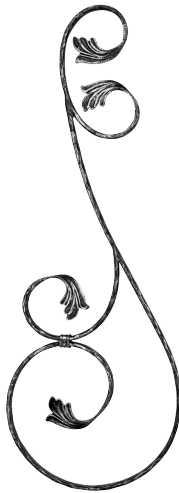

29305
□ 12x6 mm
295x800 mm
1,05 kg

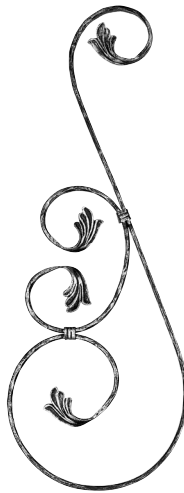

29306
□ 12x6 mm
295x800 mm
1,10 kg



29500
□ 12 mm
310x900 mm
4,40 kg



29503
Ø12 mm
310x900 mm
4,01 kg



29411
□ 12x6 mm
350x840 mm
2,25 kg



28209
□ 12 mm
240x900 mm
3,35 kg



28213
□ 12 mm
230x900 mm
3,27 kg



28214
□ 12 mm
240x900 mm
1,47 kg



28400
□ 16x7 mm
195x630 mm 900 mm
2,26 kg



28300
□ 16x7 mm
320x740 mm
3,62 kg



28301
□ 16x7 mm
320x740 mm
3,62 kg



29405
□ 16x7 mm
300x800 mm
2,89 kg

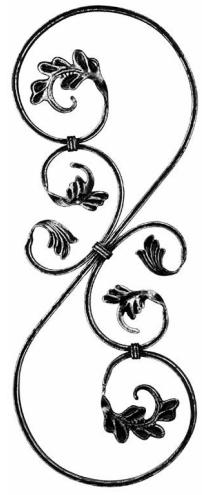

29407
□ 16x7 mm
300x800 mm
2,89 kg

Dekoratif Ferforje Paneller - Decorative Wrought Iron Panels



28402
□ 12 mm
255x315 mm
1,72 kg



28403
□ 12 mm
300x375 mm
2,15 kg

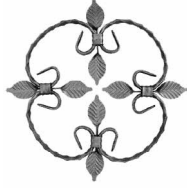

29109
□ 12x6 mm
240x240 mm
0,65 kg



29110
□ 12x6 mm
300x300 mm
0,80 kg



29111
□ 12x6 mm
300x300 mm
0,80 kg

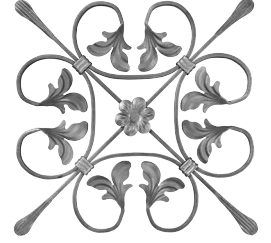

29112
□ 12x6 mm
340x340 mm
1,96 kg



29156
□ 12x6 mm
240x240 mm
0,80 kg



29157
□ 12x6 mm
300x300 mm
0,95 kg

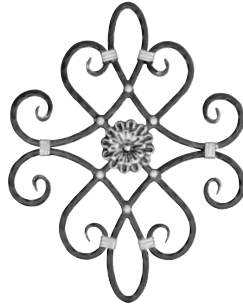

29307
□ 12 mm
425x540 mm
3,71 kg

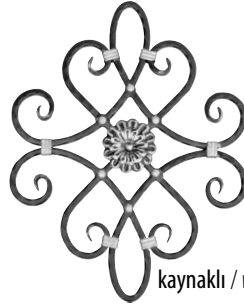

29307-A
□ 12 mm
425x540 mm
3,66 kg

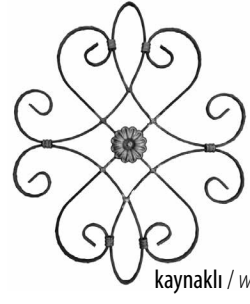

29307-B
□ 12x6 mm
425x540 mm
2,00 kg



29164
□ 12x6 mm
450x450 mm
2,41 kg

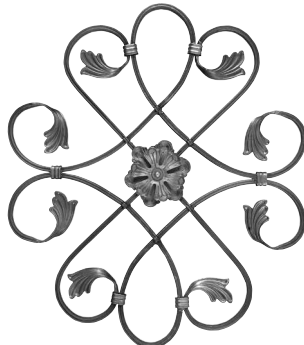

29200
□ 16x7 mm
510x590 mm
4,17 kg

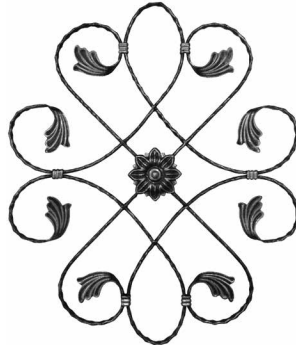

28434
□ 12x6 mm
500x590 mm
2,17 kg



29201
□ 16x7 mm
670x640 mm
5,82 kg

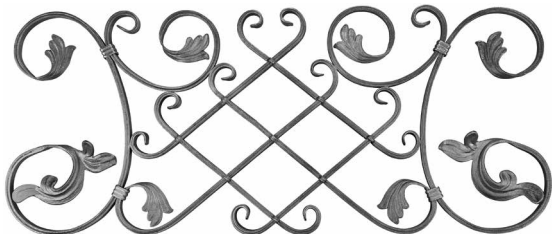

29204
□ 16x7 mm
880x370 mm
5,53 kg

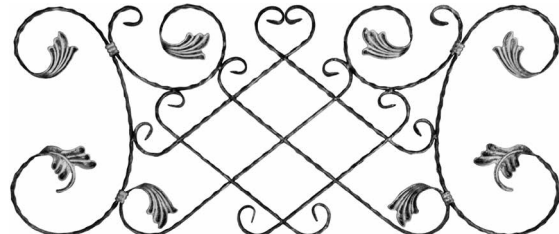

29601
□ 12x6 mm
370x880 mm
2,80 kg

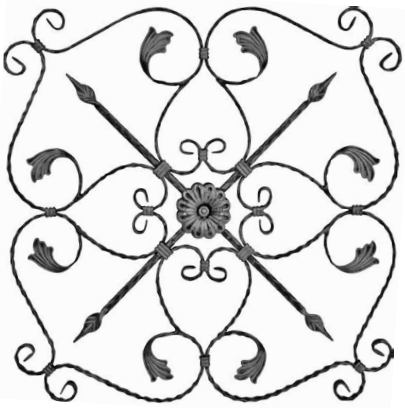

29600
□ 12x6 mm
700x700 mm
5,50 kg

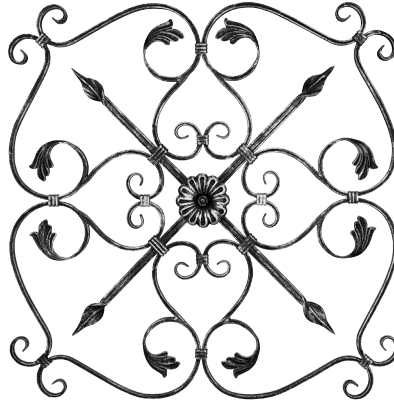

29209
□ 16x7 mm
700x700 mm
8,45 kg

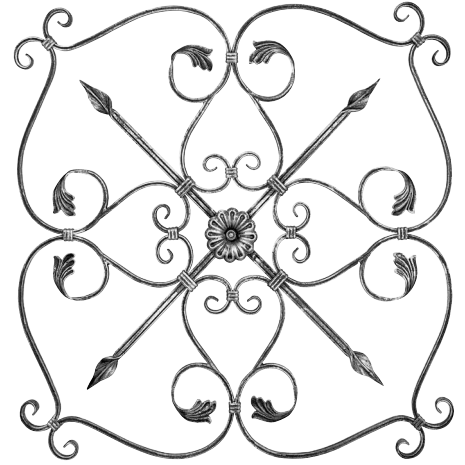

29210
□ 16x7 mm
800x800 mm
10,24 kg

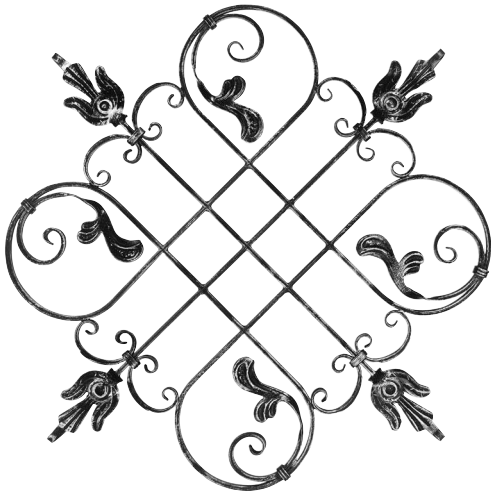

29203
□ 16x7 mm
870x870 mm
7,84 kg

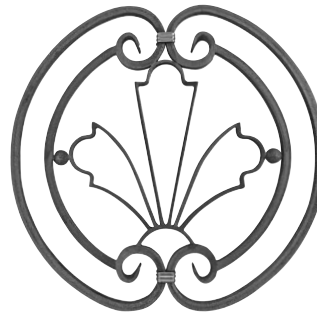

28404
□ 14 mm
540x520 mm
5,80 kg

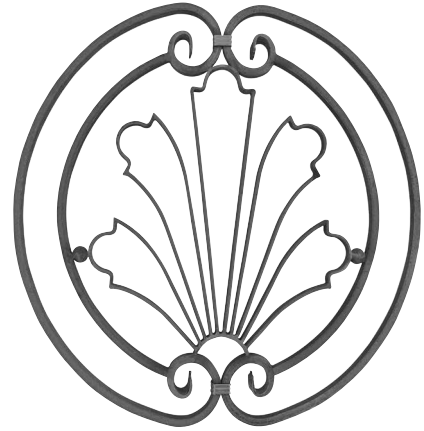

28405
□ 14 mm
680x700 mm
9,10 kg

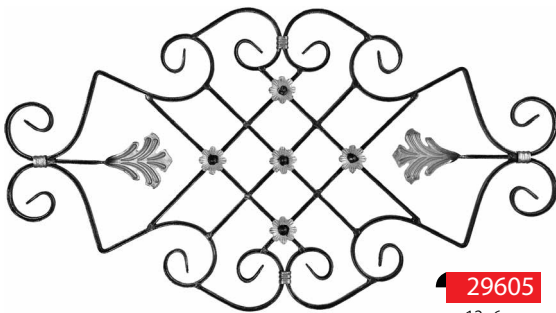

29605
□ 12x6 mm
800x440 mm
3,15 kg



29100
□ 12x6 mm
520x80 mm
0,50 kg



29106
□ 16x7 mm
520x80 mm
0,90 kg



29105
Ø12 mm
560x80 mm
0,80 kg



29105-A
□ 12 mm
560x80 mm
0,85 kg

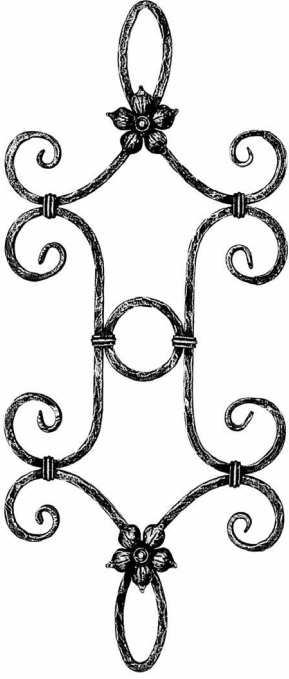

29301
□ 12 mm
385x900 mm
3,75 kg

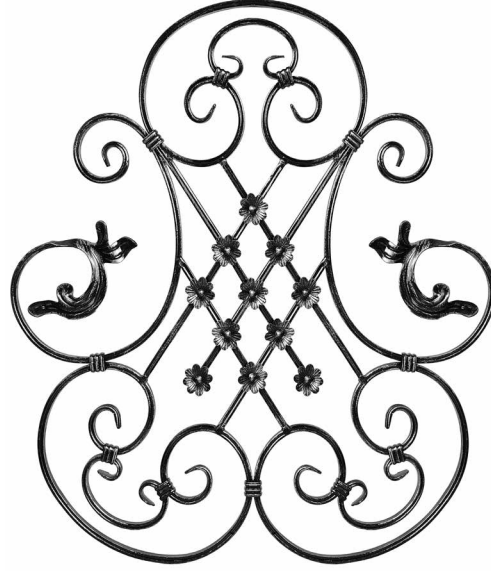

28406
□ 16x7 mm
650x700 mm
7,25 kg

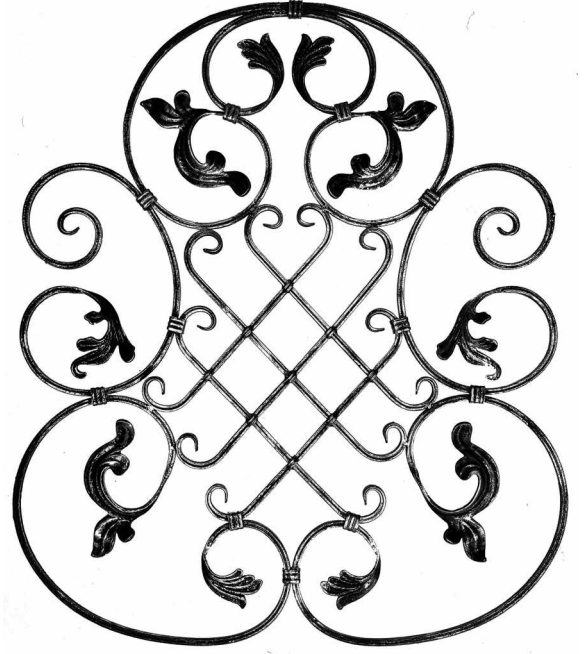

29224
□ 16x7 mm
700x800 mm
8,26 kg



kod/code : 28419
kod/code : 28422



kod/code : 28419
kod/code : 28420

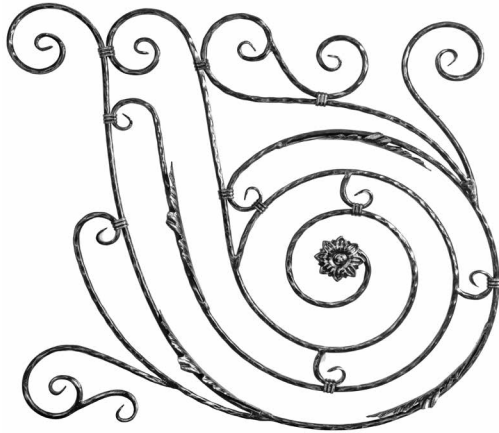

28411
Ø11 mm
940x600 mm
9,98 kg

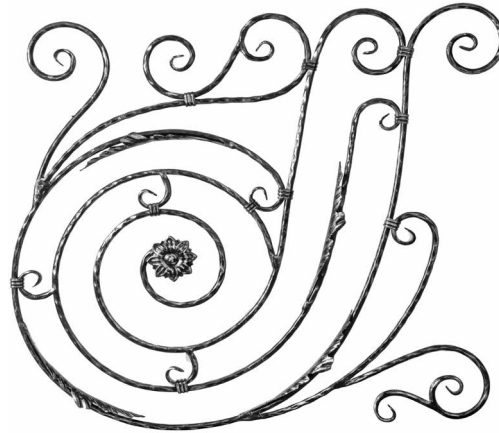

28412
Ø11 mm
940x600 mm
9,98 kg

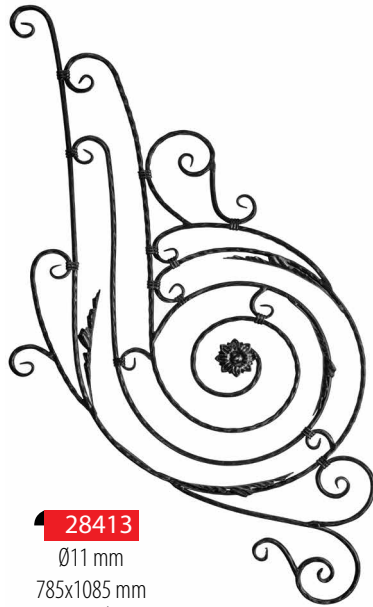

28413
Ø11 mm
785x1085 mm
10,22 kg

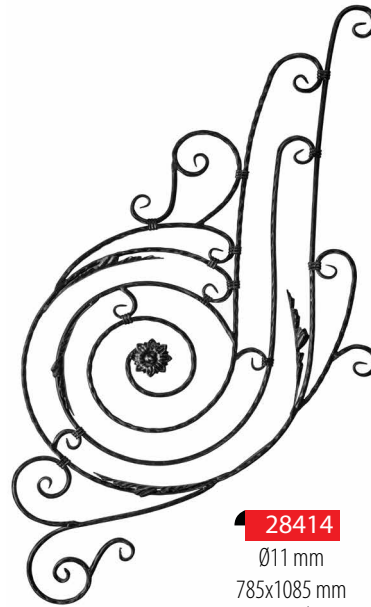

28414
Ø11 mm
785x1085 mm
10,22 kg



28421
Ø11 mm
500x880 mm
4,80 kg



28422
Ø11 mm
500x880 mm
4,80 kg



28417
Ø11 mm
720x1080 mm
5,40 kg

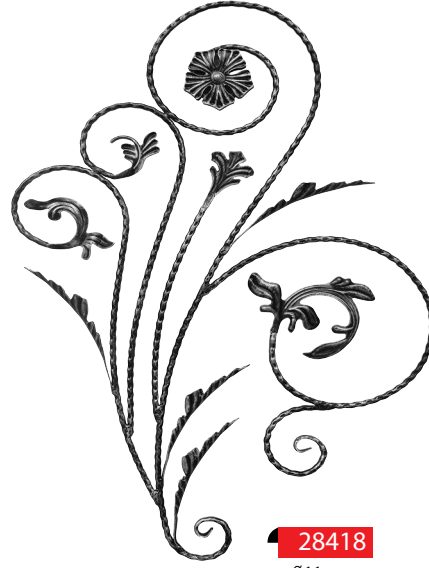

28418
Ø11 mm
720x1080 mm
5,40 kg



28419
Ø11 mm
750x880 mm
7,10 kg



28420
Ø11 mm
750x880 mm
7,10 kg



28423
Ø11 mm
750x550 mm
4,31 kg

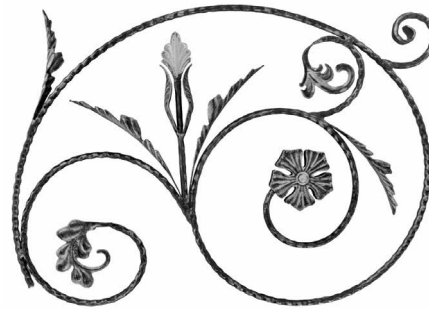

28424
Ø11 mm
750x550 mm
4,31 kg



29228
□ 16x7 mm
400x1000 mm
5,23 kg



29229
□ 16x7 mm
400x1000 mm
5,23 kg



29244
□ 16x7 mm
400x1000 mm
7,50 kg



29245
□ 16x7 mm
400x1000 mm
7,50 kg



28429
□ 16x7 mm
400x1000 mm
4,90 kg



28430
□ 16x7 mm
400x1000 mm
4,90 kg

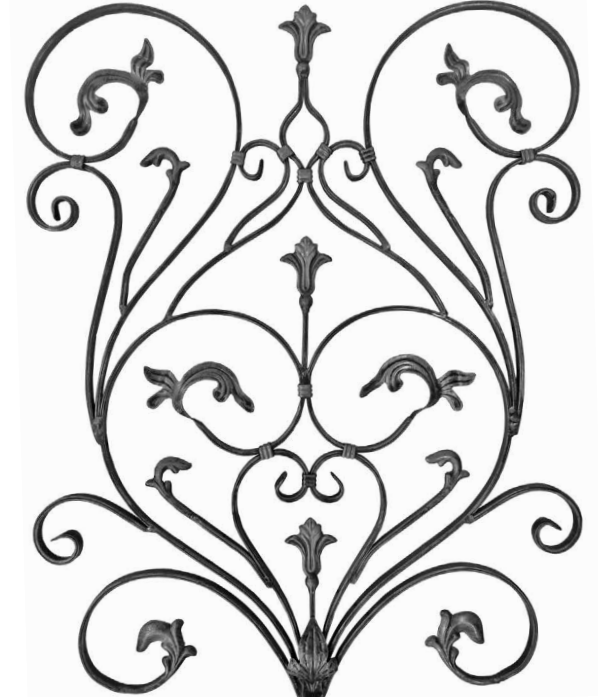

29227
□ 16x7 mm
800x1000 mm
11,58 kg

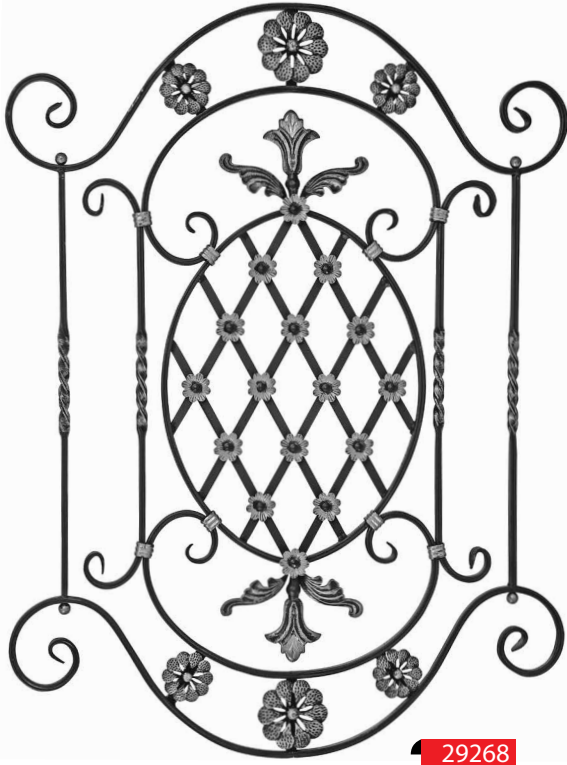

29268
□ 16x7 mm
750x1000 mm
9,45 kg



29269
□ 16x7 mm
400x1000 mm
6,15 kg

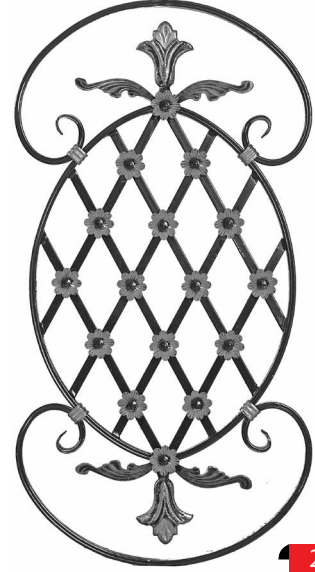

29270
□ 16x7 mm
400x750 mm
4,20 kg

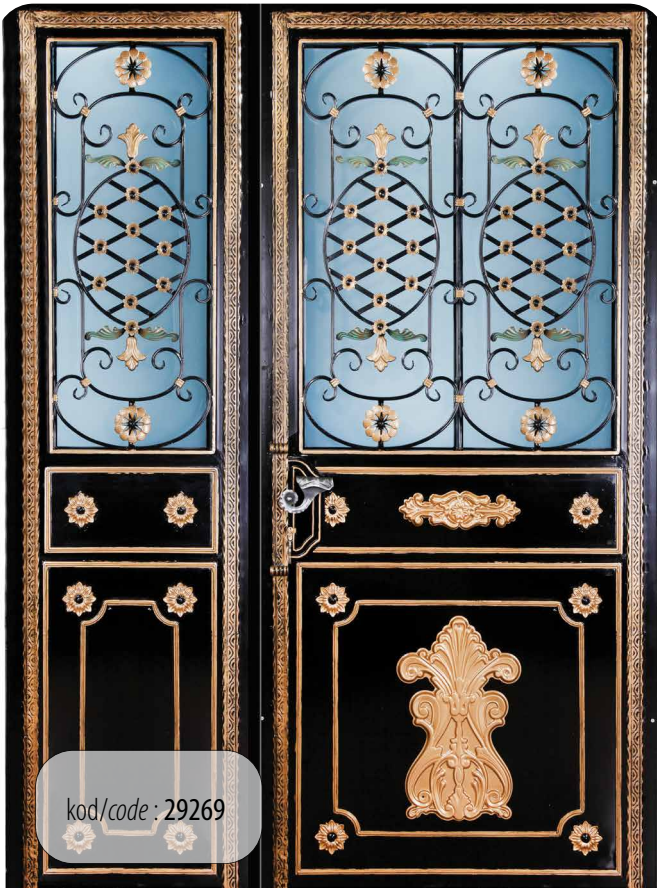

kod/code : 29269

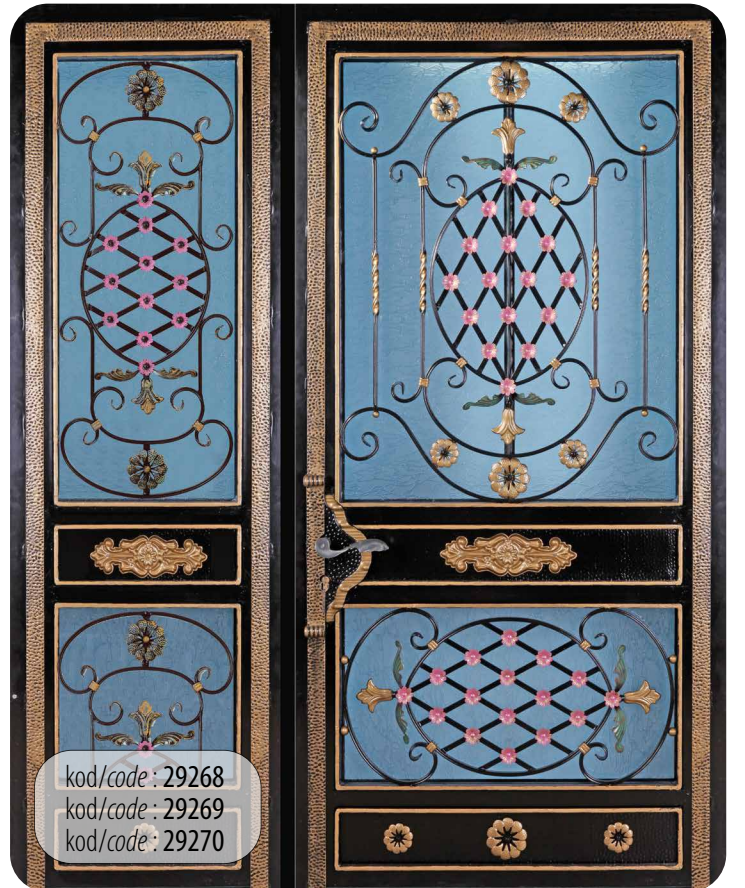

kod/code : 29268
kod/code : 29269
kod/code : 29270

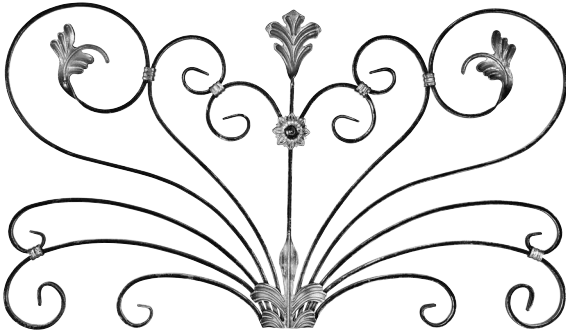

29606
□ 12x6 mm
800x460 mm
3,75 kg



29246
□ 16x7 mm
800x400 mm
5,71 kg

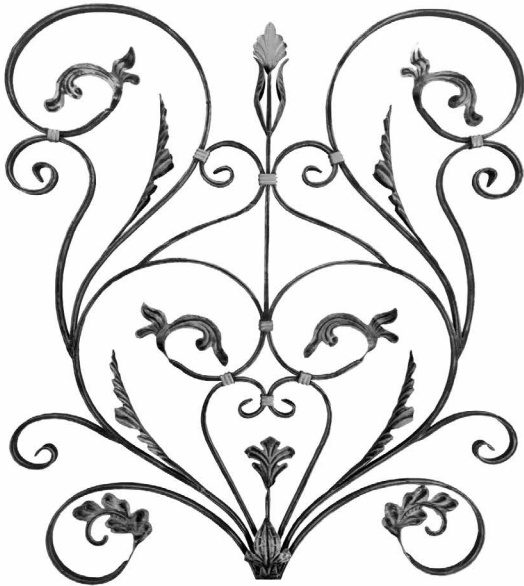

28431
□ 16x7 mm
800x1000 mm
10,59 kg



29211
Ø12 mm
500x880 mm
5,80 kg



29212
Ø12 mm
500x880 mm
5,80 kg

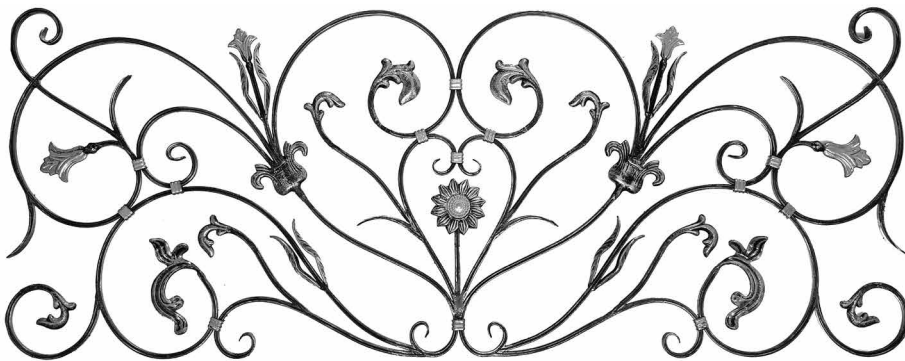

29272
□ 16x7 mm
1580x600 mm
15,00 kg



29247
□ 16x7 mm
700x610 mm
6,40 kg

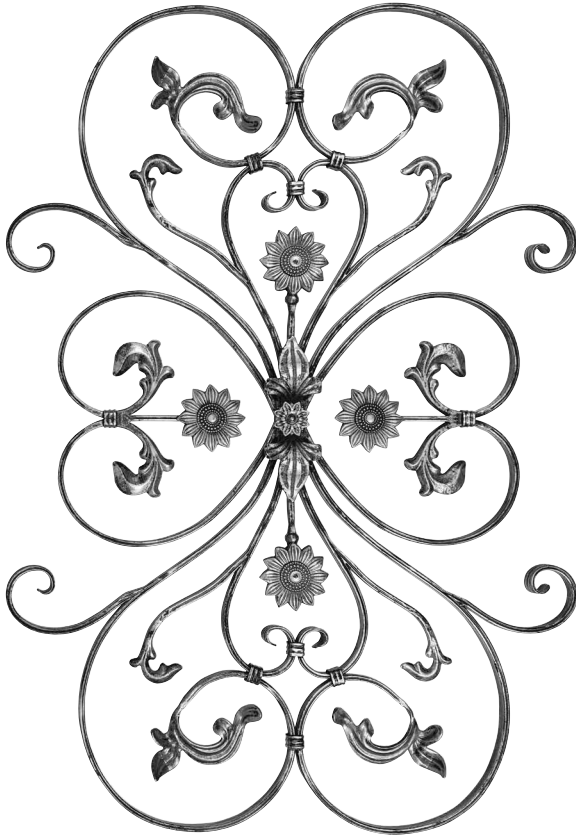

29248
□ 16x7 mm
800x1140 mm
11,58 kg

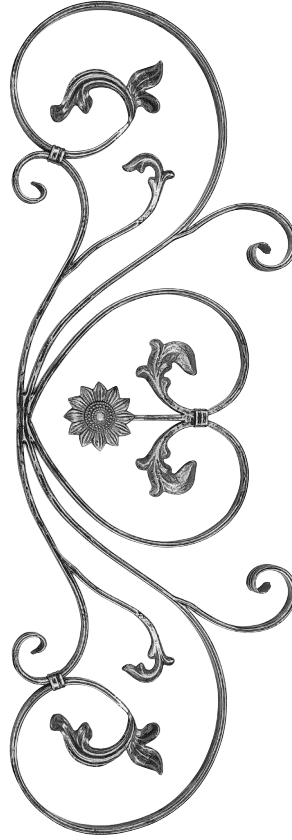

29249
□ 16x7 mm
400x1140 mm
5,91 kg

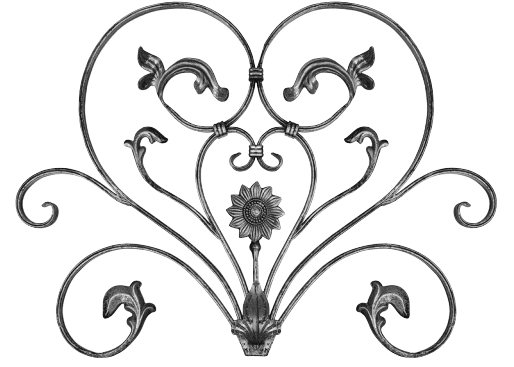

29250
□ 16x7 mm
800x570 mm
6,09 kg

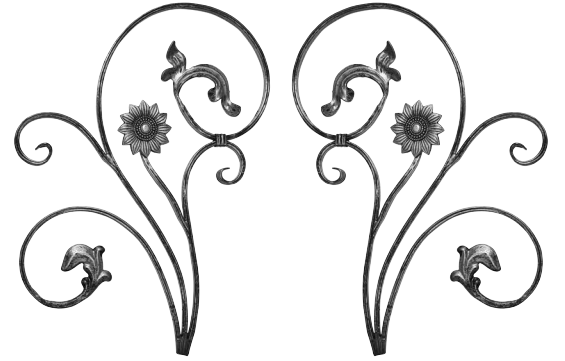

29251
□ 16x7 mm
400x570 mm
2,85 kg

29252
□ 16x7 mm
400x570 mm
2,85 kg



kod/code : 29248
kod/code : 29249
kod/code : 29250



kod/code : 2414



29205
Ø12 mm
600x1080 mm
6,40 kg



29206
Ø12 mm
600x1080 mm
6,40 kg

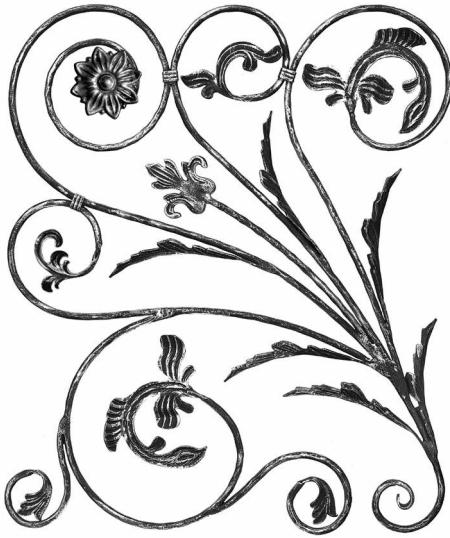

29213
Ø12 mm
750x880 mm
8,30 kg

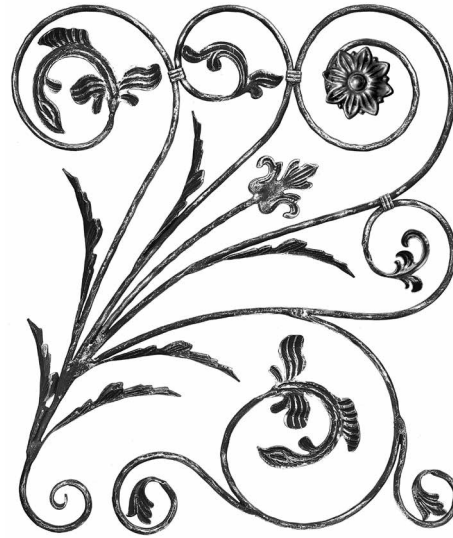

29214
Ø12 mm
750x880 mm
8,30 kg

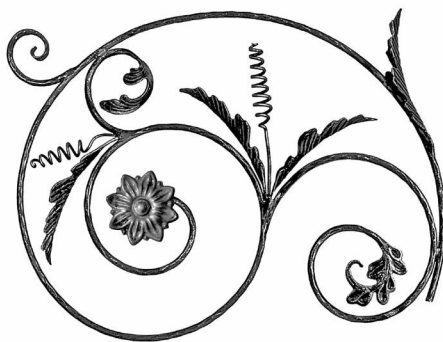

29207
Ø12 mm
750x550 mm
5,88 kg

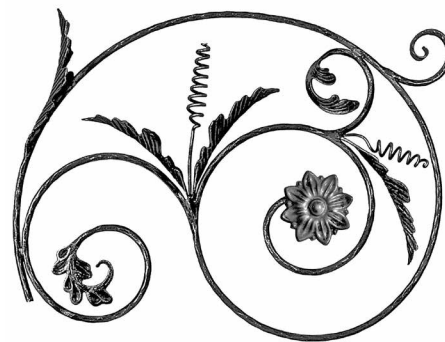

29208
Ø12 mm
750x550 mm
5,88 kg



29277
□ 16x7 mm
200x1000 mm
4,29 kg



29278
□ 16x7 mm
200x1000 mm
4,29 kg

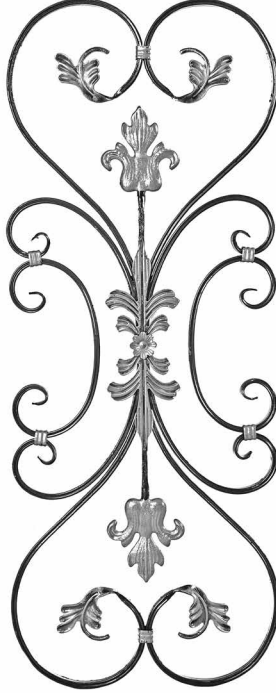

29279
□ 16x7 mm
400x1000 mm
6,70 kg

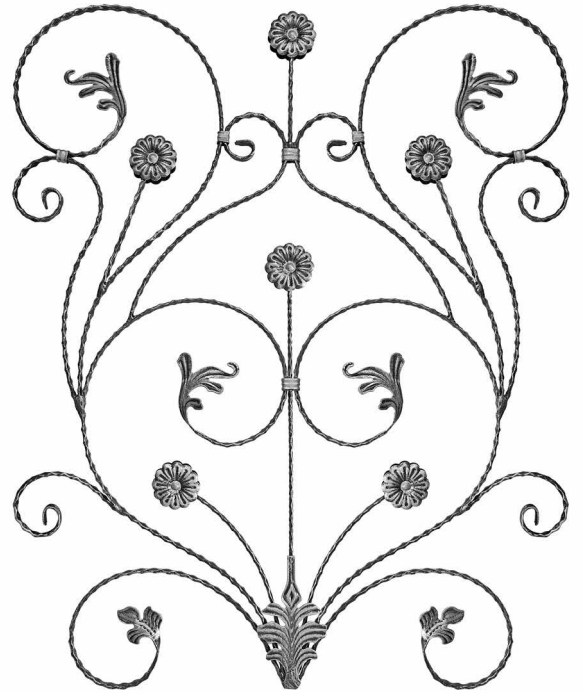

29602
□ 12x6 mm
800x1000 mm
4,69 kg

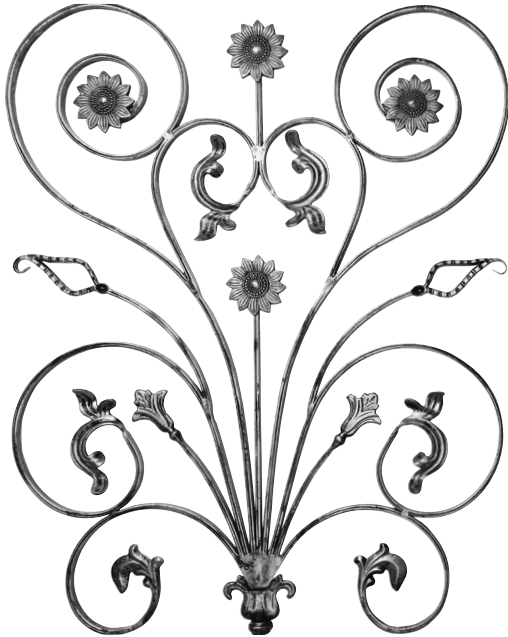

29253
□ 16x7 mm
800x1000 mm
13,14 kg



29254
□ 16x7 mm
400x1000 mm
5,86 kg



29255
□ 16x7 mm
400x1000 mm
5,86 kg

Kapı ve Pencere Başlıkları - Gate and Window Accessories



34100
□ 16x7 mm
1200x220 mm
2,64 kg



34102
□ 12x6 mm
1200x220 mm
1,43 kg



34104
□ 12x6 mm
740x230 mm
1,03 kg

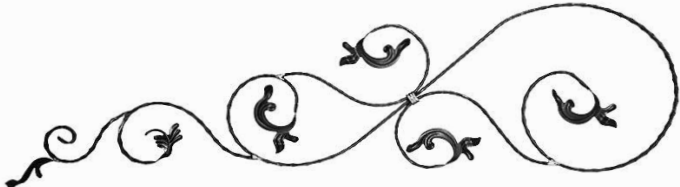

34203
□ 16x7 mm
1500x380 mm
5,65 kg

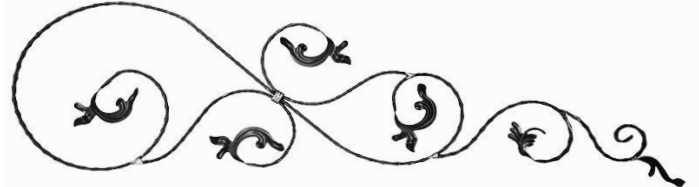

34204
□ 16x7 mm
1500x380 mm
5,65 kg

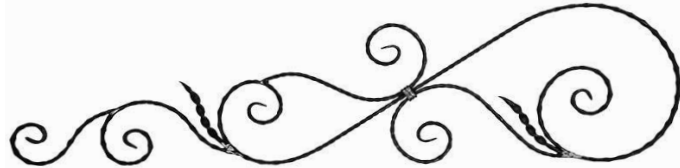

34205
□ 16x7 mm
1270x330 mm
4,54 kg

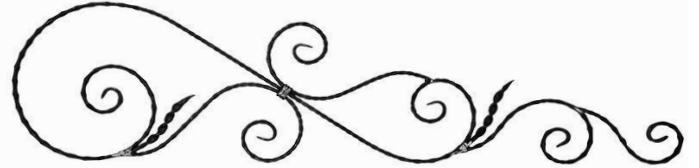

34206
□ 16x7 mm
1270x330 mm
4,54 kg



kod/code : 28417

Üzüm Dalları ve Motifleri - Grapes Rods & Panels



27300

sıcak dövme
hot forged
120x180 mm
3 mm



27303

soğuk dövme
cold forged
80x130 mm
3 mm



27304

120 mm



27305

140 mm

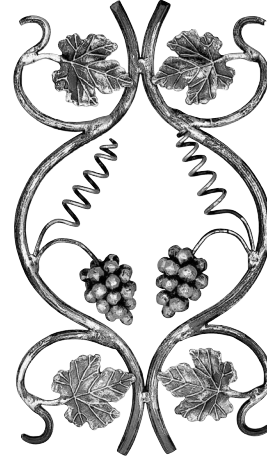

27310

Ø14 mm
285x500 mm
3,71kg



12 mm

27306

Ø12-Ø10 mm
1100 mm
0,90 kg



16 mm

27307

Ø16-Ø12 mm
1100 mm
1,54 kg



20 mm

27308

Ø20-Ø16 mm
1100 mm
2,30 kg



27309

Ø14 mm
165x800 mm
3,34 kg



27311

Ø14 mm
165x800 mm
2,72 kg



27312

Ø14 mm
215x1000 mm
5,58 kg

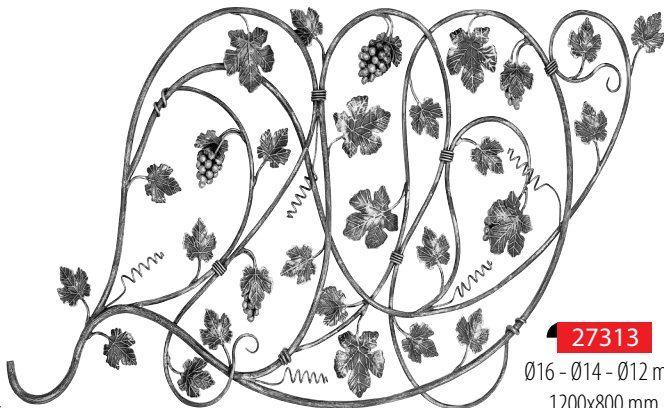

27313

Ø16-Ø14-Ø12 mm
1200x800 mm
22,20 kg

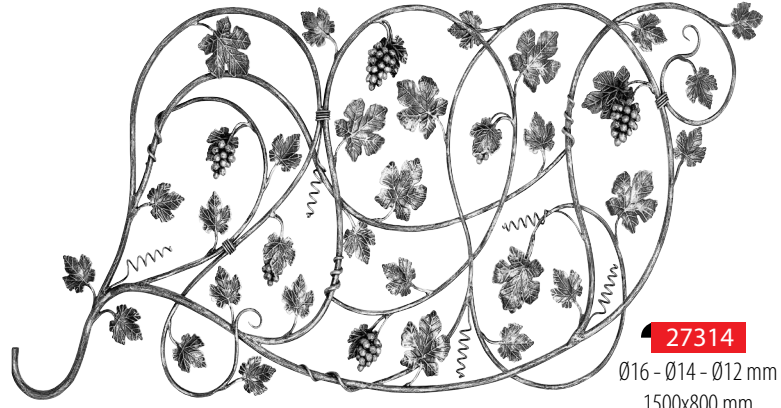

27314

Ø16-Ø14-Ø12 mm
1500x800 mm
27,50 kg



27319
Ø10 mm
240x580 mm
1,69 kg



27320
Ø10 mm
270x690 mm
2,47 kg



27321
Ø14 mm
200x600 mm 1000 mm
2,74 kg



27323
Ø14 mm
270x690 mm 1000 mm
2,72 kg



27325
Ø11 mm
160x800 mm
2,58 kg



27326
Ø11 mm
150x900 mm
2,90 kg



27327
Ø11 mm
300x900 mm
4,00 kg



29409
Ø12 mm
370x900 mm
5,45 kg



29410
Ø12 mm
300x750 mm
3,20 kg



kod/code : 28417
kod/code : 27325

Sıcak Dövme Ara Bağlantı Parçaları - Hot Forged Interconnects

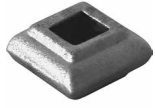

3790
33x26 mm
delik/hole: □12x12 mm

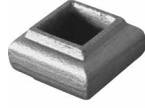

3791
36x26 mm
delik/hole: □14x14 mm



3792
60x35 mm
delik/hole: □24x24 mm



3793
33x26 mm
delik/hole: Ø14 mm



3794
36x26 mm
delik/hole: Ø16 mm



3795
60x35 mm
delik/hole: Ø24 mm

Osmanlı Cami Topuzları - Ottoman Mosque Knobs



6050
35x35 mm
delik/hole: Ø12 mm

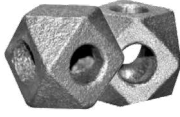

6051
40x40 mm
delik/hole: Ø16 mm



6052
50x50 mm
delik/hole: Ø18 mm



6053
35x35 mm
delik/hole: □12x12 mm

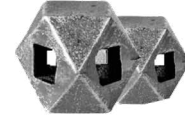

6054
40x40 mm
delik/hole: □12x12 mm

6053-A
35x35 mm
delik/hole: □16x16 mm

6054-A
40x40 mm
delik/hole: □16x16 mm

Bağlantı Elemanları - Connection Accessories

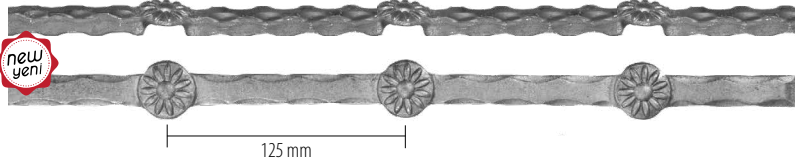

26106-B
□ 12 mm
2000 mm

26106
□ 14 mm
2000 mm

26107
□ 16 mm
2000 mm



26200
□ 12x6 mm
60x2000 mm
1,13 kg

26201
□ 16x7 mm
60x2000 mm
2,33 kg



26300
□ 16x7 mm
950x135 mm
4,02 kg

26301
□ 16x7 mm
970x170 mm
4,09 kg



26302
□ 16x7 mm
950x135 mm
3,75 kg

26303
Ø12 mm
970x170 mm
3,68 kg



26303-A
□ 16x7 mm
970x170 mm
4,03 kg

Sıcak Dövme Mızraklar - Hot Forged Spearheads

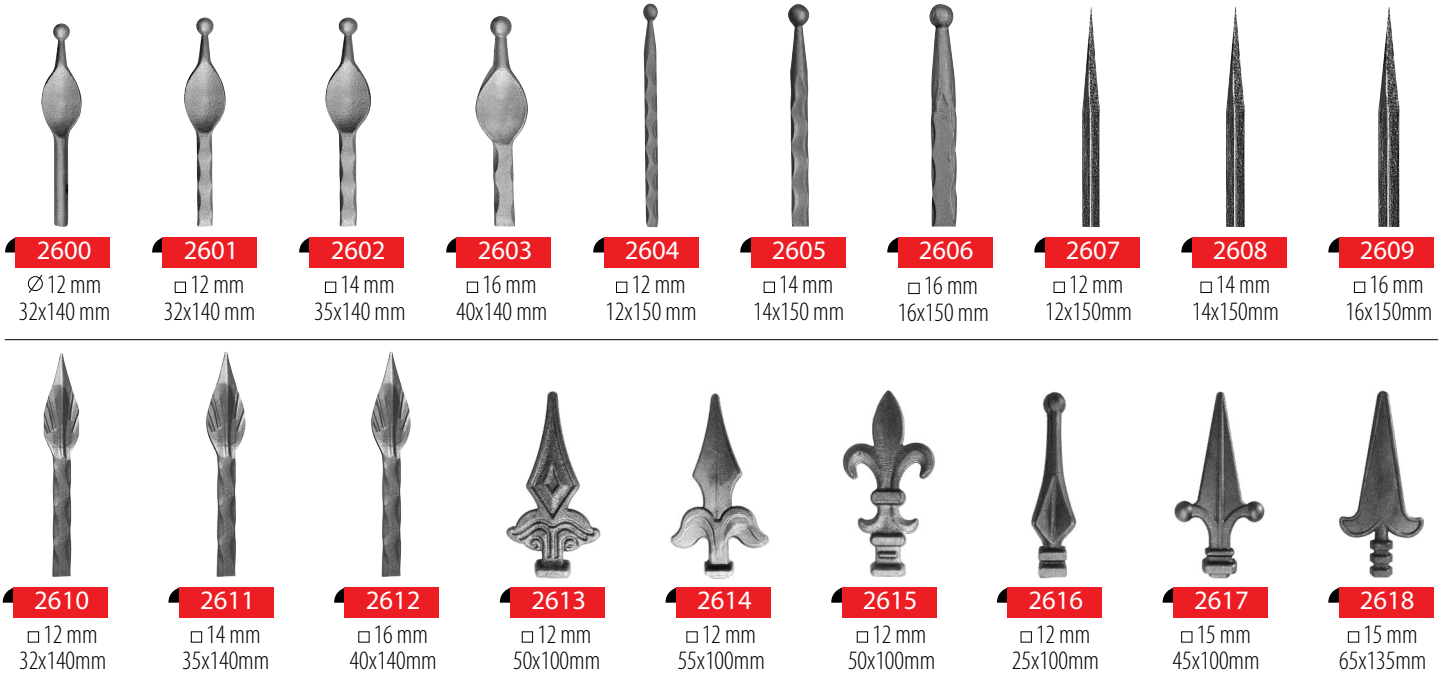

Kelepçeler - Collar Bars



Kozalaklar - Baskets



2700

□ 12 mm
130x60 mm



2701

□ 14 mm
130x65 mm



2702

□ 16 mm
145x65 mm



2703

□ 20 mm
160x95 mm



2704

□ 24 mm
180x100 mm



2705

□ 10 mm
160x28 mm



2706

□ 12 mm
160x30 mm



2707

□ 10 mm
120x43 mm

Kozalaklı Çubuklar - Basket Bars



2710

12x12 mm
800x60 mm
burgulu (twisted)



2711

12x12 mm
800x60 mm
burgulu (twisted)



2712

12x12 mm
800x60 mm
burgulu (twisted)



2713

12x12 mm
800x60 mm
burgulu (twisted)



2714

12x12 mm
800x60 mm
izli (hammered)



2715

12x12 mm
800x60 mm
izli (hammered)

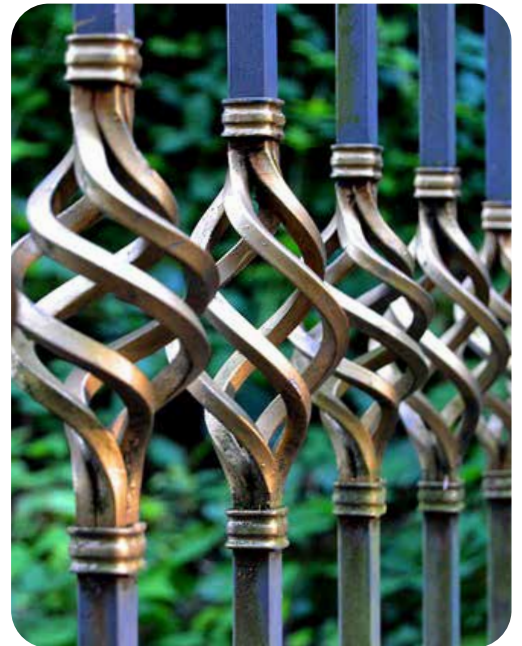

Sıcak Dövme Küreler - Hot Forged Spheres

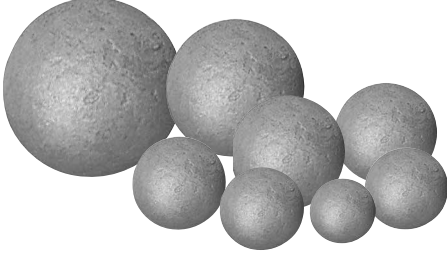

Kod Code	Ölçü Dimension	Ağırlık Weight	Kod Code	Ölçü Dimension	Ağırlık Weight
2500-A	Ø20 mm	0.04 kg	2505	Ø60 mm	1.04 kg
2500	Ø25 mm	0.08 kg	2506	Ø70 mm	1.40 kg
2501	Ø30 mm	0.14 kg	2507	Ø100 mm	4.11 kg
2503	Ø40 mm	0.30 kg	2508	Ø120 mm	7.11 kg
2504	Ø50 mm	0.60 kg			

Boş Küreler - Hollow Spheres



Kod Code	Ölçü Dimension	Ağırlık Weight	Kod Code	Ölçü Dimension	Ağırlık Weight
3139	Ø30 mm	0.020 kg	3144	Ø80 mm	0.174 kg
3140	Ø40 mm	0.034 kg	3145	Ø90 mm	0.160 kg
3141	Ø50 mm	0.062 kg	3146	Ø100 mm	0.200 kg
3142	Ø60 mm	0.080 kg	3147	Ø120 mm	0.368 kg
3143	Ø70 mm	0.100 kg	3148	Ø150 mm	0.500 kg

Halkalar - Rings



12x6 mm
düz (smooth)



12x6 mm
izli (hammered)



□ 12 mm
düz (smooth)



□ 12 mm
izli (hammered)



12x6 mm
izli (hammered)



□ 12 mm
izli (hammered)

Kod Code	Ölçü Dimension	Kod Code	Ölçü Dimension	Kod Code	Ölçü Dimension	Kod Code	Ölçü Dimension	Kod Code	Ölçü Dimension	Kod Code	Ölçü Dimension
2940	Ø80 mm	2944	Ø80 mm	2948	Ø100 mm	2952	Ø100 mm	2956	Ø100 mm	2958	Ø120 mm
2941	Ø100 mm	2945	Ø100 mm	2949	Ø120 mm	2953	Ø120 mm	2957	Ø120 mm		
2942	Ø110 mm	2946	Ø110 mm	2950	Ø130 mm	2954	Ø130 mm				
2943	Ø120 mm	2947	Ø120 mm	2951	Ø150 mm	2955	Ø150 mm				

Kabaralar - Rivets



2970
Ø25 mm
10mm



2970-A
Ø25 mm



2971
Ø25 mm
25mm Ø6 mm



2972
Ø19 mm
35mm Ø6 mm



2973
Ø19 mm
40mm Ø6 mm



2974
Ø22 mm
32 mm Ø10 mm



2975
Ø21 mm
32 mm Ø10 mm



2976
Ø18 mm
33 mm Ø10 mm



2977
Ø10 mm
25 mm Ø6 mm



2978
□ 19 mm
30mm Ø10 mm



2979
□ 8 mm
8x40 mm

Flanşlar - Flanges

Kod Code	Ölçü Dimension	Sac Kalınlığı Thickness	Kod Code	Ölçü Dimension	Sac Kalınlığı Thickness
2900	Ø33 mm	3 mm	2907	Ø52 mm	3 mm
2901	Ø35 mm	3 mm	2908	Ø60 mm	3 mm
2902	Ø40 mm	3 mm	2909	Ø70 mm	4 mm
2903	Ø42 mm	3 mm	2910	Ø80 mm	4 mm
2904	Ø45 mm	3 mm	2911	Ø100 mm	4 mm
2905	Ø48 mm	3 mm	2912	Ø120 mm	4 mm
2906	Ø50 mm	3 mm			

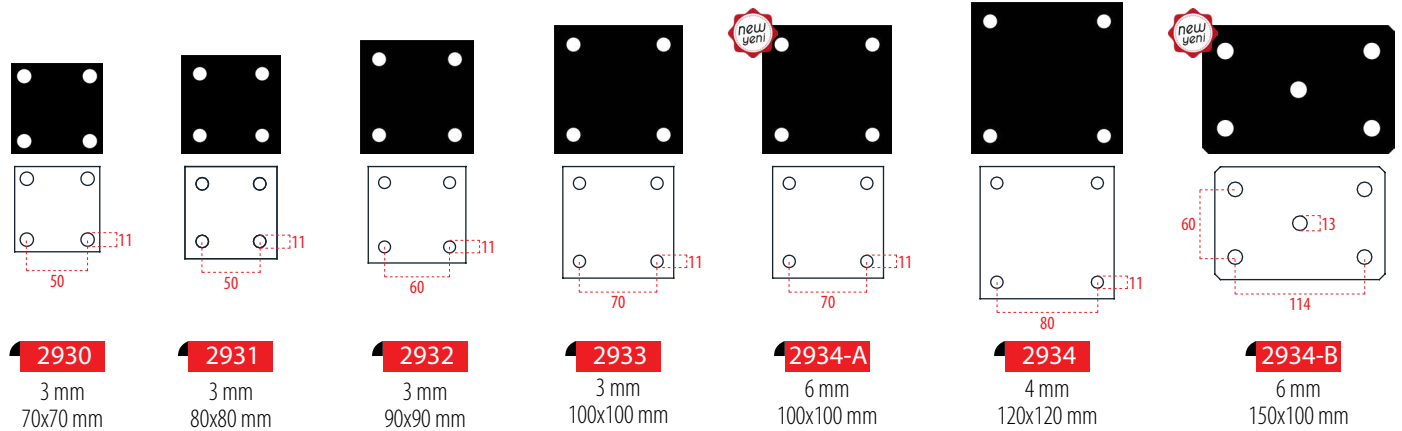
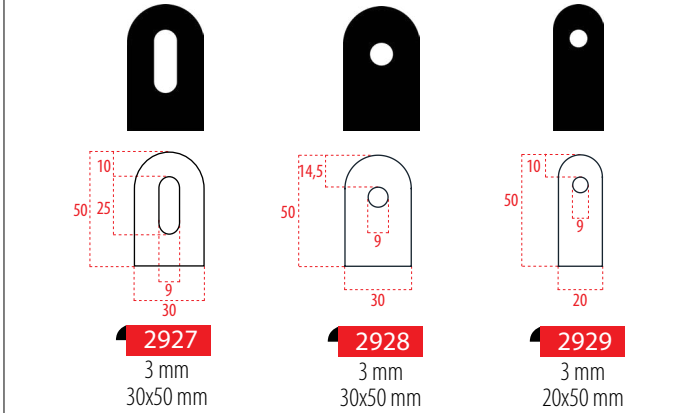
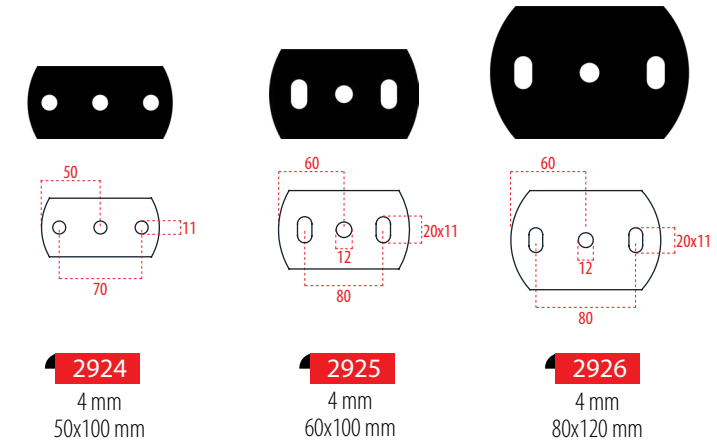
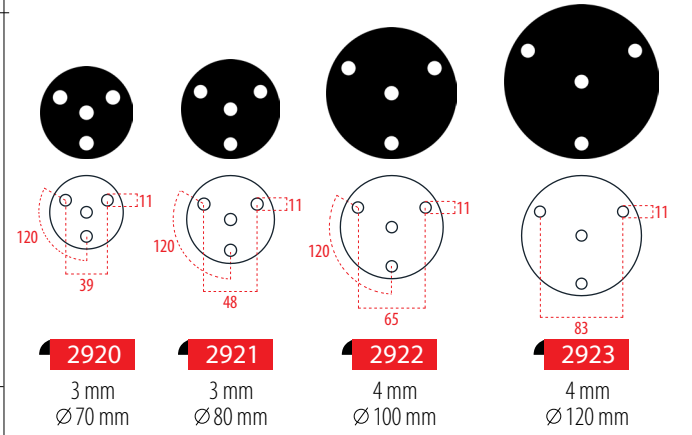
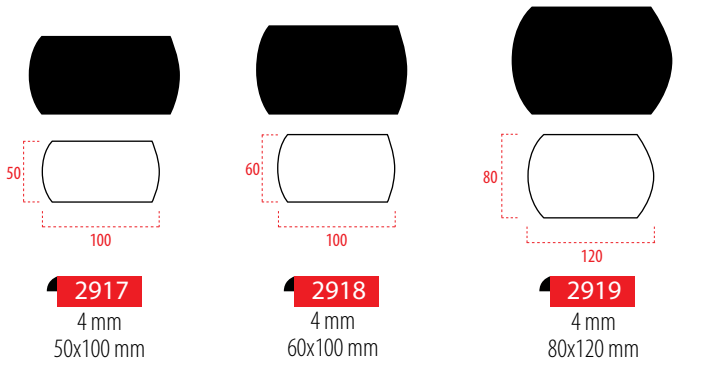
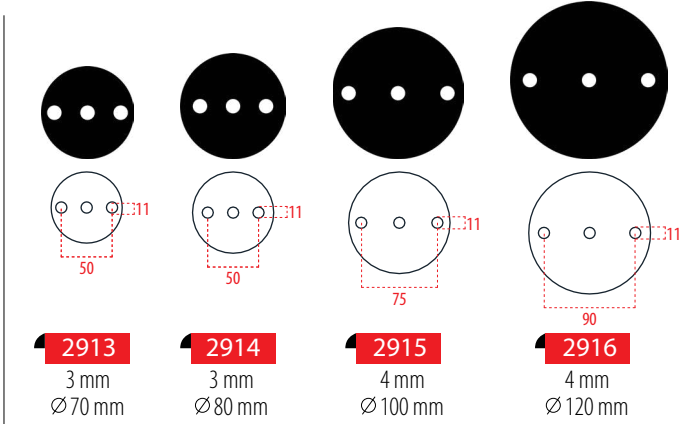

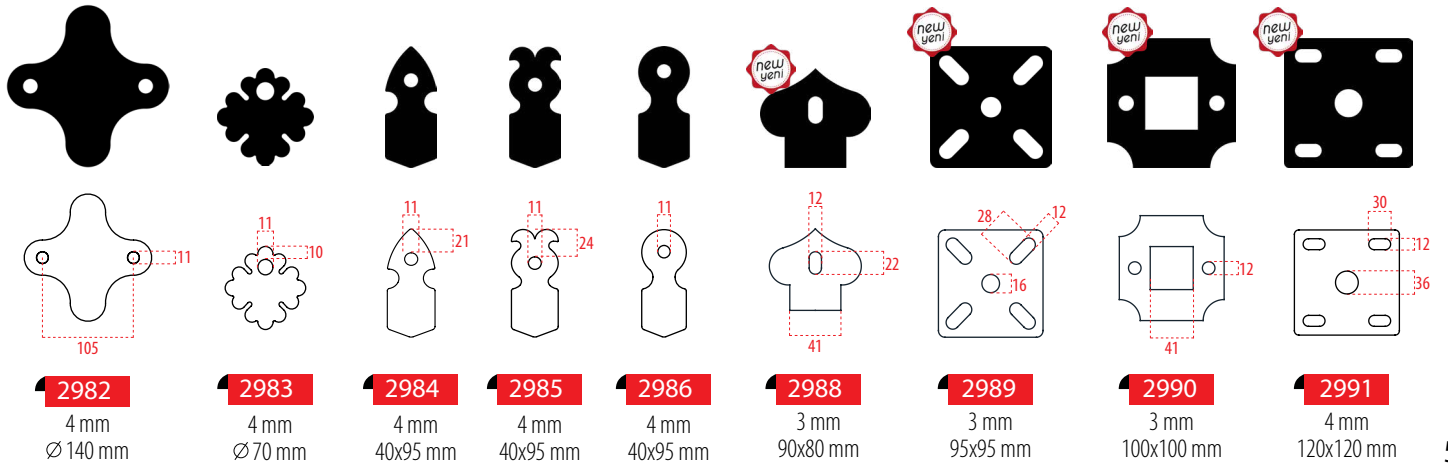
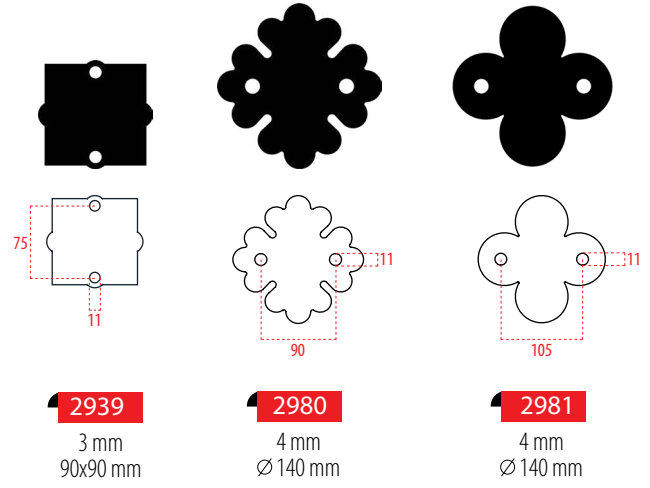
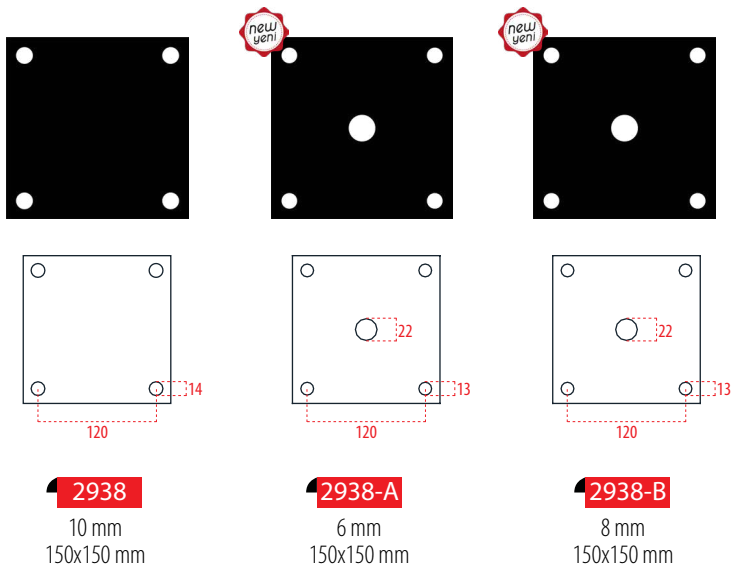
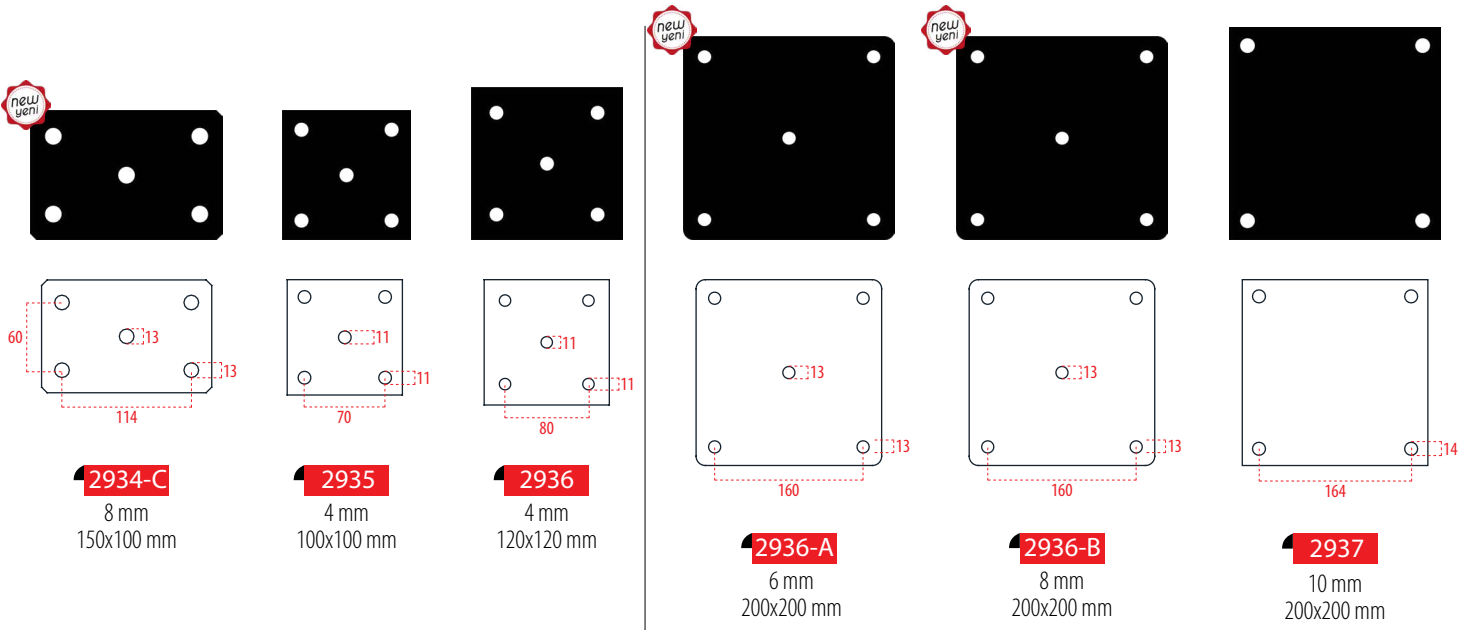

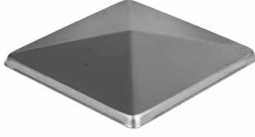
Boru & Profil Kapakları - Pipe & Profile Lids

Kod Code	İç Ölçü □ Hole	Kalınlık Thickness
3000	30x30 mm	0.7 mm
3001	40x40 mm	0.7 mm
3002	50x50 mm	0.7 mm
3003	60x60 mm	0.7 mm
3004	80x80 mm	0.7 mm
3005	100x100 mm	0.7 mm

Kod Code	İç Ölçü □ Hole	Yükseklik Height	Kalınlık Thickness
3006-A	120x120 mm	30 mm	0.7 mm
3007-A	150x150 mm	30 mm	0.7 mm
3008-A	175x175 mm	30 mm	0.7 mm
3009-A	200x200 mm	30 mm	0.7 mm



Kod Code	İç Ölçü □ Hole	Kalınlık Thickness
3010	50x100 mm	0.7 mm
3011	40x80 mm	0.7 mm
3012	40x60 mm	0.7 mm
3013	30x60 mm	0.7 mm
3014	30x50 mm	0.7 mm
3015	30x40 mm	0.7 mm
3016	20x40 mm	0.7 mm
3017	20x30 mm	0.7 mm

Kod Code	İç Ölçü ∅ Hole	Kalınlık Thickness
3020	∅30 mm	0.7 mm
3021	∅33 mm	0.7 mm
3022	∅42 mm	0.7 mm
3023	∅48 mm	0.7 mm
3024	∅51 mm	0.7 mm
3025	∅60 mm	0.7 mm
3026	∅76 mm	0.7 mm
3027	∅90 mm	0.7 mm
3028	∅101 mm	0.7 mm
3029	∅114 mm	0.7 mm



Kod Code	İç Ölçü ∅ Hole	Kalınlık Thickness
3030	∅19 mm	1.2 mm
3031	∅32 mm	1.2 mm
3032	∅38 mm	1.2 mm
3033	∅42 mm	1.2 mm
3034	∅48 mm	1.2 mm
3035	∅51 mm	1.2 mm
3036	∅60 mm	1.2 mm
3036-A	∅76 mm	1.2 mm
3036-B	∅96 mm	1.2 mm
3037	∅101 mm	1.2 mm

Kod Code	İç Ölçü ∅ Hole	Kalınlık Thickness
3039	∅30 mm	1.0 mm
3040	∅40 mm	1.0 mm
3041	∅50 mm	1.0 mm
3042	∅60 mm	1.0 mm
3043	∅70 mm	1.0 mm
3044	∅80 mm	1.0 mm
3045	∅90 mm	1.0 mm
3046	∅100 mm	1.0 mm
3047	∅120 mm	1.0 mm
3048	∅150 mm	1.0 mm



Kod Code	İç Ölçü ∅ Hole
3050	∅30 mm
3051	∅33 mm
3052	∅42 mm
3053	∅48 mm
3054	∅51 mm
3055	∅60 mm
3056	∅76 mm
3057	∅90 mm
3058	∅101 mm
3059	∅114 mm

Kod Code	İç Ölçü □ Hole	Kalınlık Thickness
3060	51x75 mm	1.2 mm
3061	58x96 mm	1.2 mm
3062	68x102 mm	1.2 mm





Kod Code	İç Ölçü □ Hole	Kod Code	İç Ölçü □ Hole
3063	30x30 mm	3068	100x100 mm
3064	40x40 mm	3069	120x120 mm
3065	50x50 mm	3070	150x150 mm
3066	60x60 mm	3071	175x175 mm
3067	80x80 mm	3072	200x200 mm

Kod Code	İç Ölçü □ Hole	Yükseklik Height	Kalınlık Thickness
3076	60x60 mm	100 mm	1.0 mm
3077	80x80 mm	125 mm	1.0 mm
3073	100x100 mm	130 mm	1.5 mm
3074	120x120 mm	140 mm	1.5 mm
3075	150x150 mm	160 mm	1.5 mm
3078	175x175 mm	165 mm	1.5 mm

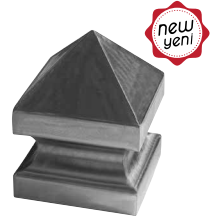

Plastik Kapaklar - Plastic Lids



Kod Code	Ölçü Dimension	Kod Code	Ölçü Dimension
2720	15x15 mm	2726	60x60 mm
2721	20x20 mm	2727	70x70 mm
2722	25x25 mm	2728	80x80 mm
2723	30x30 mm	2729	100x100 mm
2724	40x40 mm	2730	120x120 mm
2725	50x50 mm		

Kod Code	Ölçü Dimension	Kod Code	Ölçü Dimension
2731	Ø25 mm	2736	Ø40 mm
2732	Ø30 mm	2737	Ø42 mm
2733	Ø32 mm	2738	Ø48 mm
2734	Ø35 mm	2739	Ø50 mm
2735	Ø38 mm		



Kod Code	Ölçü Dimension	Kod Code	Ölçü Dimension
2747	20x30 mm	2752	30x60 mm
2748	20x40 mm	2753	40x60 mm
2749	30x40 mm	2754	40x80 mm
2750	25x50 mm	2755	50x100 mm
2751	30x50 mm		

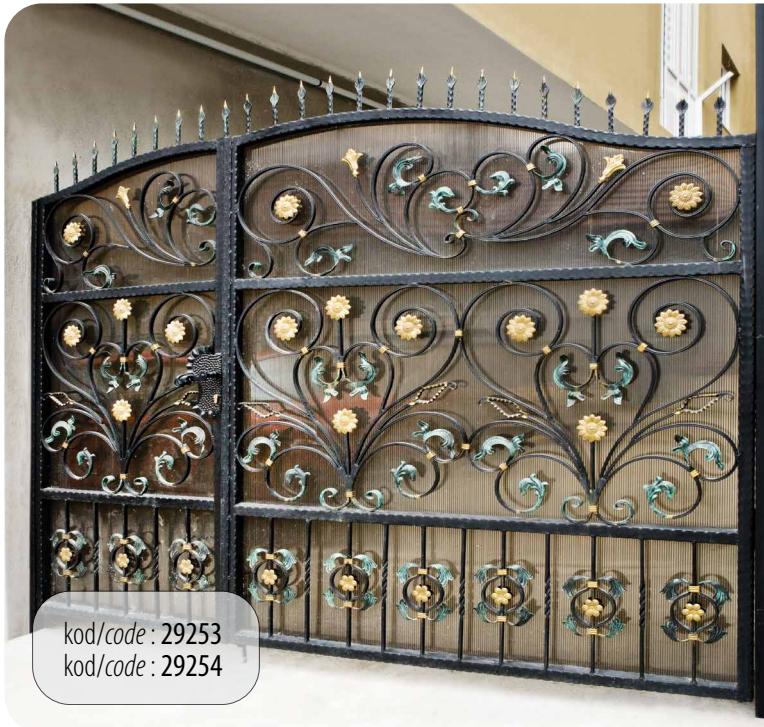

kod/code : 29253
kod/code : 29254



kod/code : 28419
kod/code : 28420

Boru & Profil Flanşları - Pipe & Profile Flanges

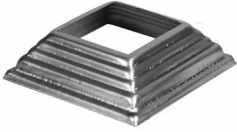

Kod Code	İç Ölçü □ Hole	Dış Ölçü Width	Yükseklik Height
3100	12x12 mm	50x50 mm	20 mm
3101	14x14 mm	50x50 mm	20 mm
3102	16x16 mm	50x50 mm	20 mm
3106	20x20 mm	70x70 mm	25 mm
3107	25x25 mm	70x70 mm	25 mm
3108	30x30 mm	70x70 mm	25 mm
3108-A	30x30 mm	90x90 mm	28 mm
3109	40x40 mm	90x90 mm	28 mm
3110	50x50 mm	100x100 mm	28 mm
3111	60x60 mm	100x100 mm	28 mm
3112	80x80 mm	120x120 mm	28 mm
3113	100x100 mm	140x140 mm	28 mm

Kod Code	İç Ölçü ∅ Hole	Dış Ölçü Width	Yükseklik Height
3120	∅12 mm	∅50 mm	16 mm
3121	∅14 mm	∅50 mm	16 mm
3122	∅16 mm	∅50 mm	16 mm
3123	∅25 mm	∅80 mm	25 mm
3124	∅28 mm	∅80 mm	25 mm
3125	∅32 mm	∅80 mm	25 mm
3126	∅38 mm	∅97 mm	30 mm
3127	∅42 mm	∅97 mm	30 mm
3128	∅48 mm	∅97 mm	30 mm
3129	∅51 mm	∅110 mm	30 mm
3130	∅60 mm	∅110 mm	30 mm



Kod Code	İç Ölçü Hole	Dış Ölçü Width	Yükseklik Height
3103	20x40 mm	90x90 mm	28 mm
3104	20x30 mm	70x70 mm	25 mm
3105	30x50 mm	100x100 mm	28 mm
3116	20x10 mm	45x65 mm	24 mm
3117	30x10 mm	45x65 mm	24 mm
3115	30x40 mm	90x90 mm	28 mm
3118	40x10 mm	45x85 mm	24 mm
3114	40x60 mm	100x100 mm	28 mm
3119	50x10 mm	45x85 mm	24 mm

Kod Code	İç Ölçü Hole	Dış Ölçü Width	Yükseklik Height
3133	26x51 mm	∅76 mm	16 mm



Kod Code	İç Ölçü Hole	Dış Ölçü Width	Yükseklik Height
3134	56x54 mm	∅90 mm	16 mm



kod/code : 26106
kod/code : 26303-A

Dövmе Rozetler - Forged Rosettes

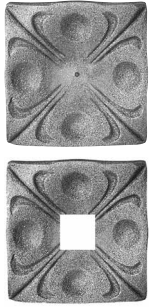

sıcak dövme - hot forged

Kod Code	Ölçü Dimension	Delik Ölçüsü Hole Size	Kalınlık Thickness
3750	80x80 mm	-	4 mm
3751	80x80 mm	21x21 mm	4 mm
3752	80x80 mm	26x26 mm	4 mm
3753	80x80 mm	31x31 mm	4 mm

sıcak dövme - hot forged

Kod Code	Ölçü Dimension	Delik Ölçüsü Hole Size	Kalınlık Thickness
3754	60x60 mm	-	4 mm
3755	60x60 mm	13x13 mm	4 mm
3756	60x60 mm	17x17 mm	4 mm



sıcak dövme - hot forged

Kod Code	Ölçü Dimension	Delik Ölçüsü Hole Size	Kalınlık Thickness
3757	60x60 mm	-	6 mm
3758	60x60 mm	13x13 mm	6 mm
3759	60x60 mm	17x17 mm	6 mm

sıcak dövme - hot forged

Kod Code	Ölçü Dimension	Delik Ölçüsü Hole Size	Kalınlık Thickness
3760	80x80 mm	-	4 mm
3761	80x80 mm	21x21 mm	4 mm
3762	80x80 mm	26x26 mm	4 mm
3763	80x80 mm	21x11 mm	4 mm
3764	80x80 mm	31x11 mm	4 mm
3765	80x80 mm	41x11 mm	4 mm



sıcak dövme - hot forged

Kod Code	Ölçü Dimension	Delik Ölçüsü Hole Size	Kalınlık Thickness
3766	110x110 mm	-	8 mm
3767	110x110 mm	31x31 mm	8 mm
3768	110x110 mm	41x41 mm	8 mm
3769	110x110 mm	51x51 mm	8 mm
3770	110x110 mm	31x41 mm	8 mm
3771	110x110 mm	41x61 mm	8 mm
3772	110x110 mm	41x21 mm	8 mm

sıcak dövme - hot forged

Kod Code	Ölçü Dimension	Delik Ölçüsü Hole Size	Kalınlık Thickness
3773	65x65 mm	-	4 mm
3774	65x65 mm	13x13 mm	4 mm
3775	65x65 mm	17x17 mm	4 mm

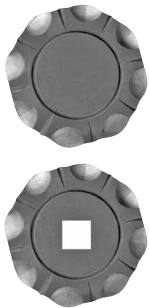

soğuk dövme - cold forged

Kod Code	Ölçü Dimension	Delik Ölçüsü Hole Size	Kalınlık Thickness
3776	Ø 65 mm	-	3 mm
3777	Ø 65 mm	13x13 mm	3 mm
3778	Ø 65 mm	17x17 mm	3 mm
3779	Ø 90 mm	-	3 mm
3780	Ø 90 mm	21x21 mm	3 mm
3781	Ø 90 mm	26x26 mm	3 mm

sıcak dövme - hot forged

Kod Code	Ölçü Dimension	Delik Ölçüsü Hole Size	Kalınlık Thickness
3782	110x110 mm	-	4 mm
3783	110x110 mm	21x21 mm	4 mm
3784	110x110 mm	26x26 mm	4 mm

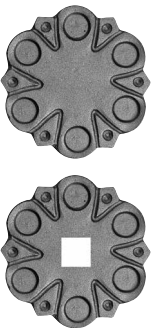

Rozetler - Rosettes

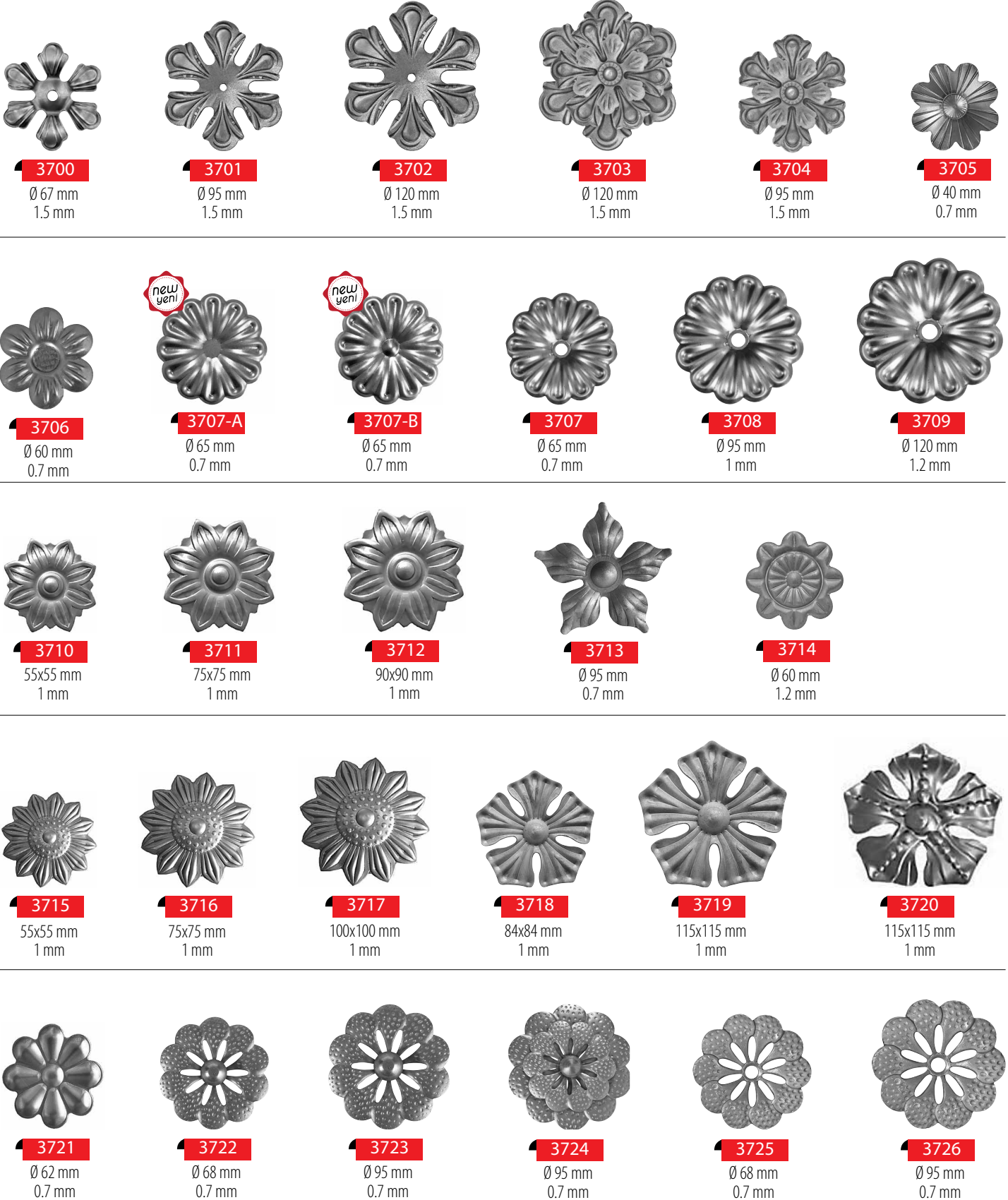



3727

Ø 120 mm
0.7 mm



3728

Ø 152 mm
0.7 mm

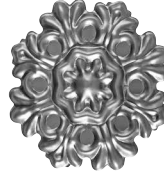

3729

Ø 140 mm
0.7 mm

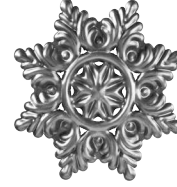

3730

155x155 mm
0.7 mm



3737

Ø 223 mm
0.7 mm



3731

Ø 152 mm
0.7 mm



3732

Ø 200 mm
0.7 mm



3733

Ø 250 mm
0.7 mm

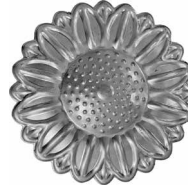

3734

Ø 152 mm
0.7 mm

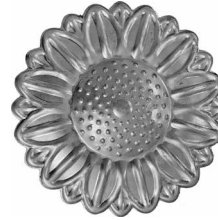

3735

Ø 200 mm
0.7 mm

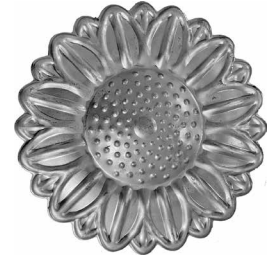

3736

Ø 250 mm
0.7 mm



3738

Ø 283 mm
0.7 mm



3739

Ø 250 mm
0.7 mm



3924

82x82 mm
0.70 mm



3925

85x85 mm
0.70 mm



3926

105x105 mm
0.70 mm



3927

200x200 mm
0.70 mm

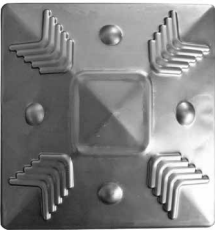

3928

210x210 mm
0.70 mm



3929

105x105 mm
0.70 mm



3930

155x155 mm
0.70 mm



3931

200x200 mm
0.70 mm



3932

250x250 mm
0.70 mm



3974

□ 14 mm 49x49 mm
1 mm

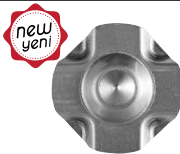

3975

□ 16 mm 49x49 mm
1 mm



3976

Ø 14 mm 49x49 mm
1 mm



3977

Ø 16 mm 49x49 mm
1 mm

Yapraklar - Leaves



3800

60x100 mm
1.5 mm



3801

80x100 mm
1.5 mm



3802

75x100 mm
1.5 mm

new
yeni



3803-A

80x100 mm
1.2 mm



3803

80x140 mm
1.2 mm

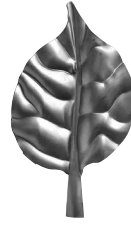

3804

107x190 mm
1.2 mm



3805

45x70 mm
0.70 mm



3806

79x77 mm
0.70 mm



3807

93x103 mm
0.70 mm



sıcak dövme - hot forged

3808

□ 13 mm
90x90 mm



sıcak dövme - hot forged

3809

□ 13 mm
75x100 mm



3810

40x125 mm
0.70 mm



3812

98x196 mm
1.5 mm



3813

45x150 mm
1.5 mm



3814

110x170 mm
1.5 mm



3815

75x180 mm
1.5 mm



new
yeni

3864

85x96 mm
1.2 mm



3816

120x142 mm
0.70 mm



3817

120x142 mm
0.70 mm



sıcak dövme - hot forged

3818

110x345 mm
4 mm



sıcak dövme - hot forged

3819

90x305 mm
4 mm



3820

125x210 mm
1.5 mm



3821

125x210 mm
1.5 mm



3822

sıcak dövme - hot forged
105x345 mm
4 mm



3823

soğuk dövme - cold forged
105x345 mm
2 mm

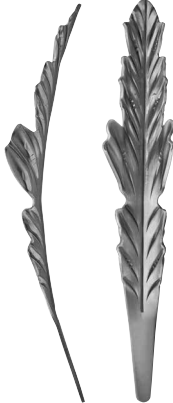

3824

47x285 mm
1.5 mm



3825

60x240 mm
1.5 mm

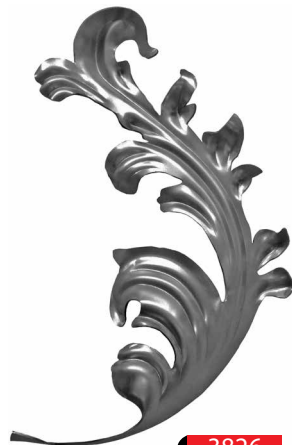

3826

175x295 mm
1.5 mm



3827

175x295 mm
1.5 mm



3828
60x100 mm
1.5 mm

3829
60x100 mm
1.5 mm

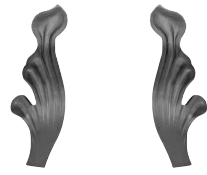

3830
50x100 mm
1.5 mm

3831
50x100 mm
1.5 mm



3832
90x110 mm
1.5 mm

3833
90x110 mm
1.5 mm

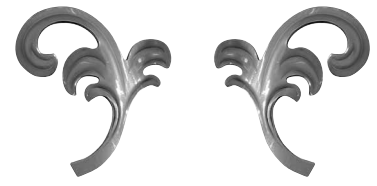

3834
116x115 mm
1.5 mm

3835
116x115 mm
1.5 mm



3836
73x56 mm
1.5 mm

3837
73x56 mm
1.5 mm

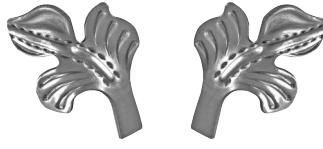

3838
65x90 mm
1.5 mm

3839
65x90 mm
1.5 mm



3840
80x80 mm
2 mm

3841
80x80 mm
2 mm



3842
100x87 mm
1.3 mm

3843
100x87 mm
1.3 mm



3844
130x100 mm
1.5 mm

3845
130x100 mm
1.5 mm



3846
53x95 mm
1.5 mm

3847
53x95 mm
1.5 mm



3848
160x90 mm
1.5 mm

3849
160x90 mm
1.5 mm



3850
30x90 mm
1.5 mm

3851
30x90 mm
1.5 mm



3852
40x115 mm
1.5 mm



3853
40x115 mm
1.5 mm



3854
50x113 mm
1.5 mm



3855
50x113 mm
1.5 mm



3856
80x120 mm
1.5 mm



3857
80x120 mm
1.5 mm

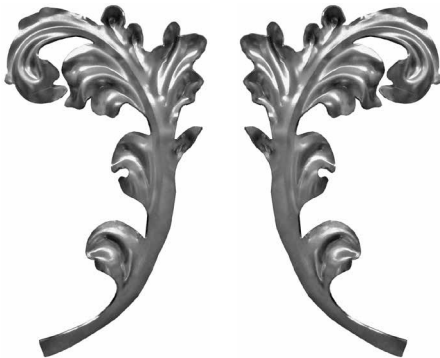

3858
135x230 mm
2 mm

3859
135x230 mm
2 mm

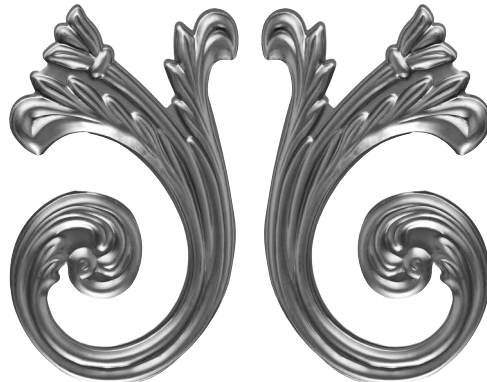

3860
175x275 mm
0.70 mm

3861
175x275 mm
0.70 mm

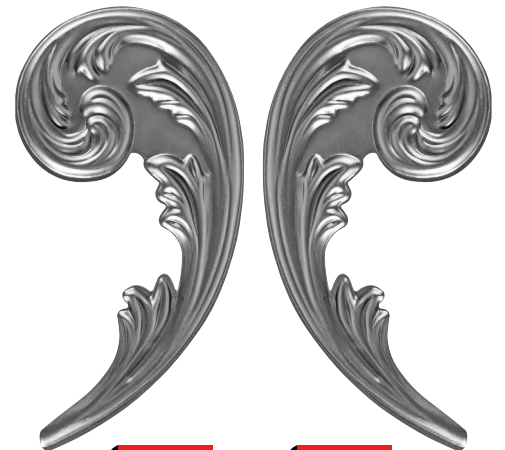

3862
160x300 mm
0.70 mm

3863
160x300 mm
0.70 mm

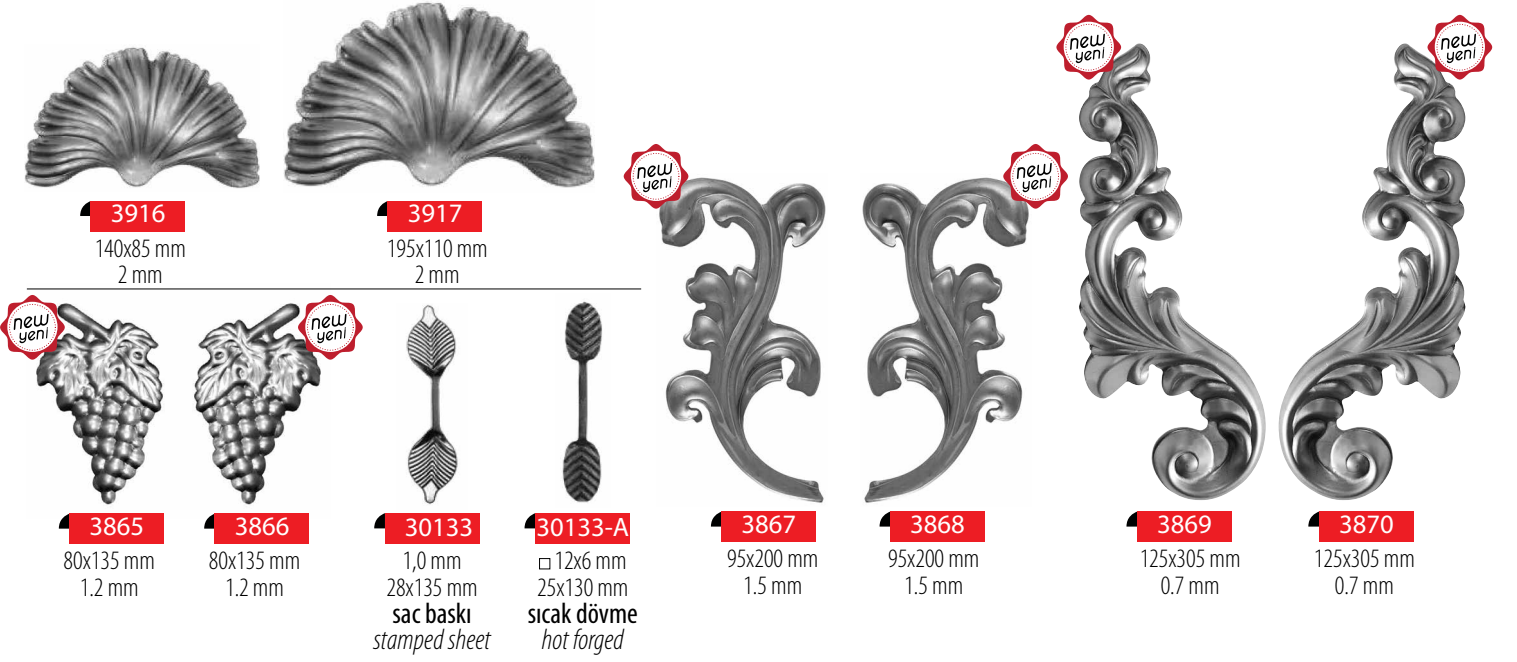

Sac Motifler - Sheet Motifs

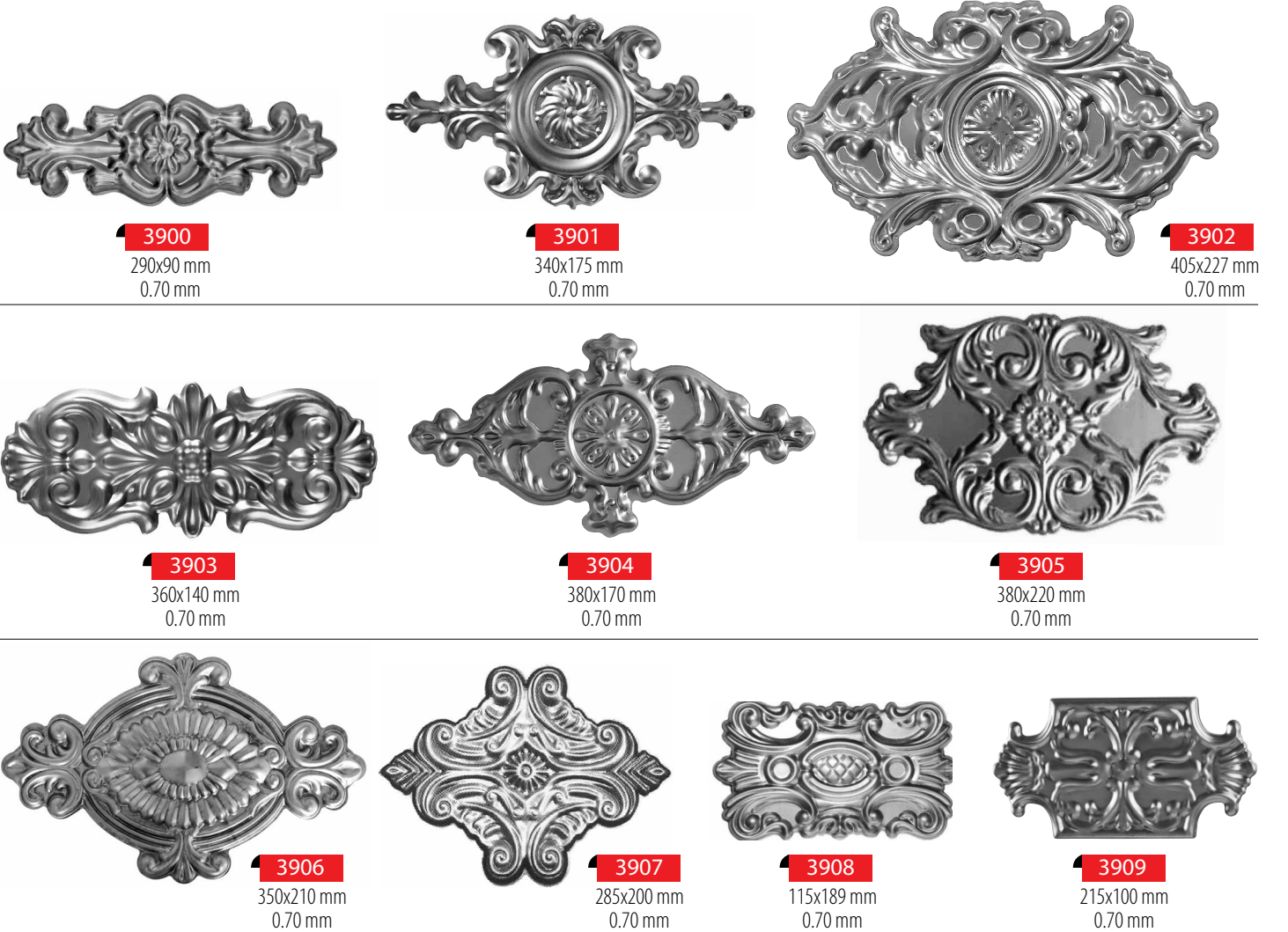



3910
350x235 mm
0.70 mm



3911
345x170 mm
0.70 mm

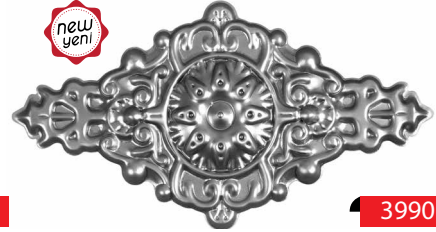

3990
360x195 mm
0.80 mm



3991
375x100 mm
0.70 mm



3992
355x170 mm
0.70 mm



3993
260x235 mm
0.70 mm



3994
440x275 mm
0.70 mm



3918
365x180 mm
0.70 mm



3920
470x290 mm
0.70 mm



3923
393x168 mm
0.70 mm

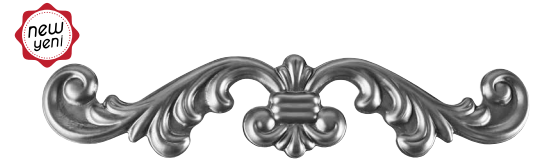

3995
465x95 mm
0.80 mm



3996
650x200 mm
0.70 mm

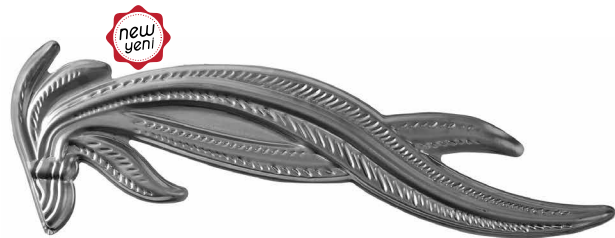

3997
650x200 mm
0.70 mm



3912
240x383 mm
0.70 mm

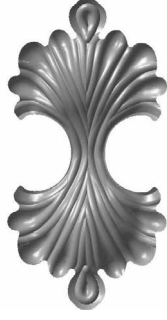

3913
125x246 mm
1.5 mm



3914
235x350 mm
0.70 mm



3919
285x570 mm
0.70 mm



3919-A
150x350 mm
0.70 mm



3946
295x580 mm
0.70 mm



3921
375x465 mm
0.70 mm



3947
254x466 mm
0.70 mm



3948
455x500 mm
0.70 mm



3949
275x378 mm
0.70 mm



3933
125x125 mm
0.70 mm



3934
135x135 mm
0.70 mm



3935
164x164 mm
0.70 mm



3936-A
150x150 mm
0.70 mm



3936
270x270 mm
0.80 mm



3939
145x145 mm
0.70 mm



3940
145x145 mm
0.70 mm



3941
165x165 mm
0.70 mm



3942
115x115 mm
0.70 mm

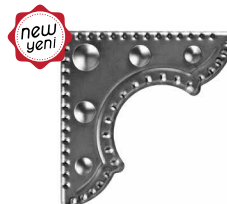

3943
130x130 mm
0.70 mm

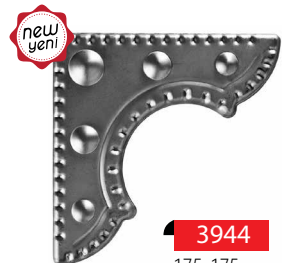

3944
175x175 mm
0.70 mm



3937

240x240 mm
0.70 mm

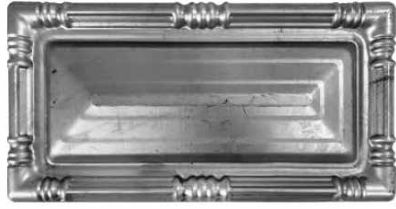

3938

485x240 mm
0.70 mm



3915

345x205 mm
0.70 mm

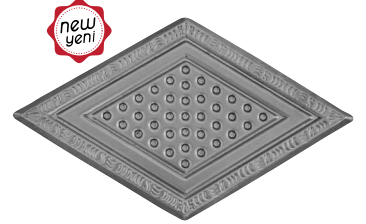

3945

345x205 mm
0.70 mm

Ara Parçalar - Connection Pieces



3670

Ø 120 mm
0.70 mm



3671

Ø 120 mm
0.70 mm



3672

Ø 120 mm
0.70 mm



3673

Ø 120 mm
0.70 mm



3674

Ø 125 mm
0.70 mm

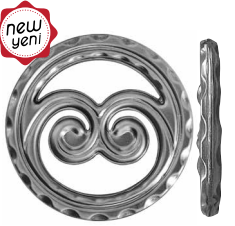

3675

Ø 125 mm
0.70 mm

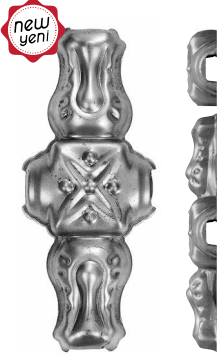

3676

□ 12x12 mm
60x145 mm
0.70 mm

3677

□ 14x14 mm
60x145 mm
0.70 mm

3678

□ 16x16 mm
60x145 mm
0.70 mm



3679

□ 12x12 mm
40x126 mm
0.70 mm

3680

□ 14x14 mm
40x126 mm
0.70 mm

3681

□ 16x16 mm
40x126 mm
0.70 mm



3682

Ø 12 mm
40x126 mm
0.70 mm

3683

Ø 14 mm
40x126 mm
0.70 mm

3684

Ø 16 mm
40x126 mm
0.70 mm



3685

□ 12x12 mm
60x145 mm
0.70 mm

3686

□ 14x14 mm
60x145 mm
0.70 mm

3687

□ 16x16 mm
60x145 mm
0.70 mm



3688

□ 12x12 mm
40x126 mm
0.70 mm

3689

□ 14x14 mm
40x126 mm
0.70 mm

3690

□ 16x16 mm
40x126 mm
0.70 mm



3691

Ø 12 mm
40x126 mm
0.70 mm

3692

Ø 14 mm
40x126 mm
0.70 mm

3693

Ø 16 mm
40x126 mm
0.70 mm

Sac Göbekler - Sheet Centers

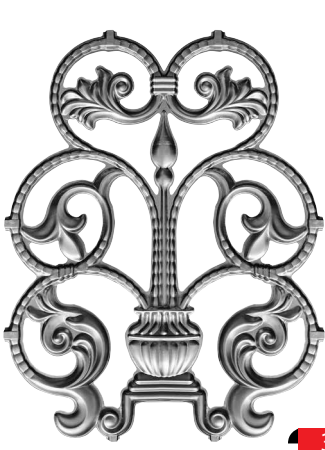

3501
0.70 mm
595x725 mm
tek (single)

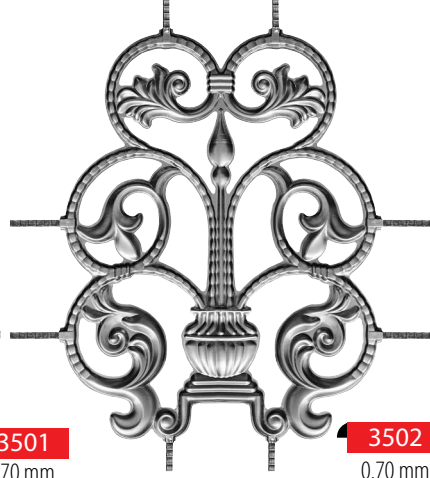

3502
0.70 mm
595x900 mm
çift-kaynaklı
(double-welded)

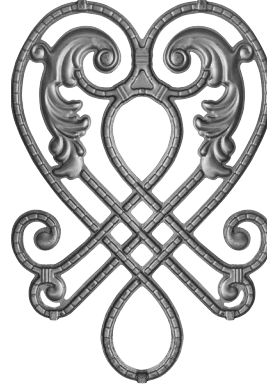

3503
0.70 mm
470x670 mm
tek (single)

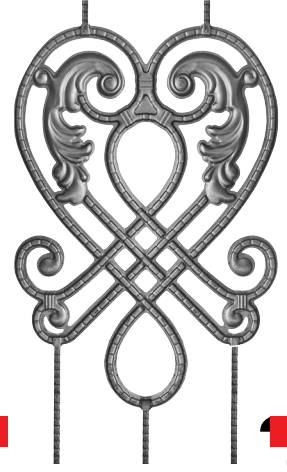

3504
0.70 mm
470x900 mm
çift-kaynaklı
(double-welded)

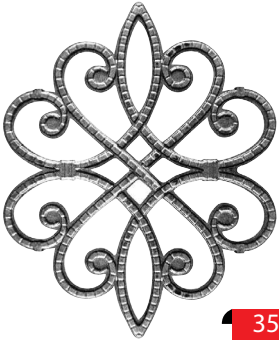

3505
0.70 mm
490x630 mm
tek (single)

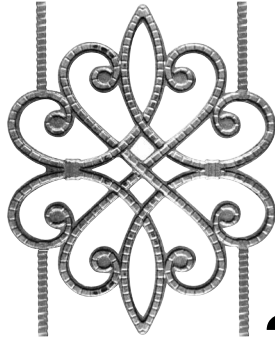

3506
0.70 mm
490x900 mm
çift-kaynaklı
(double-welded)



3507
0.70 mm
620x620 mm
tek (single)



3508
0.70 mm
620x900 mm
çift-kaynaklı
(double-welded)

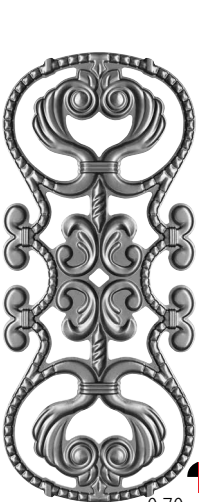

3551
0.70 mm 340x774 mm
tek (single)

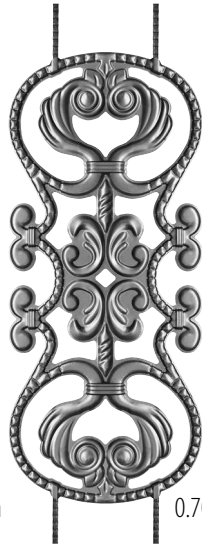

3552
0.70 mm 340x900 mm
çift-kaynaklı
(double-welded)

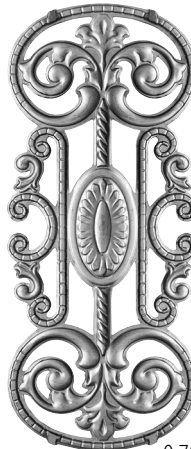

3553
0.70 mm 330x780 mm
tek (single)

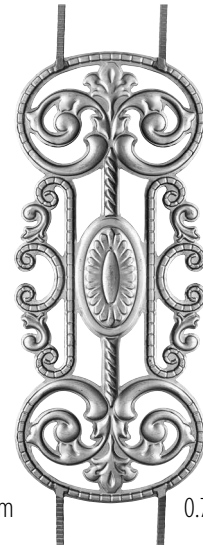

3554
0.70 mm 330x900 mm
çift-kaynaklı
(double-welded)

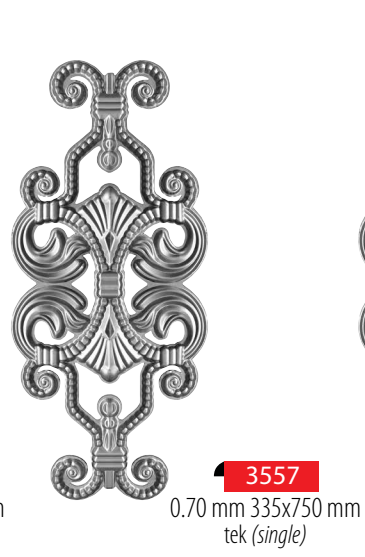
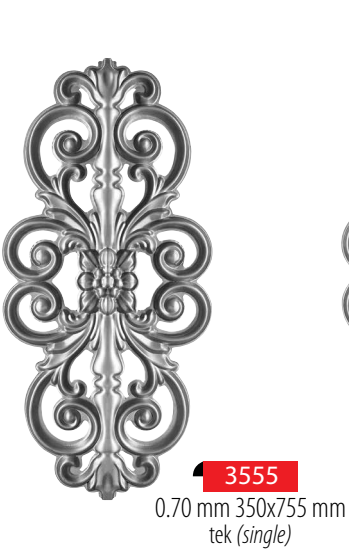



3566
0.70 mm 300x765 mm
tek (single)



3567
0.70 mm 300x900 mm
çift-kaynaklı
(double-welded)



3568
0.70 mm 365x795 mm
tek (single)



3569
0.70 mm 365x900 mm
çift-kaynaklı
(double-welded)



3570
0.70 mm 230x755 mm
tek (single)



3571
0.70 mm 230x900 mm
çift-kaynaklı
(double-welded)



3572
0.70 mm 67x850 mm
tek (single)

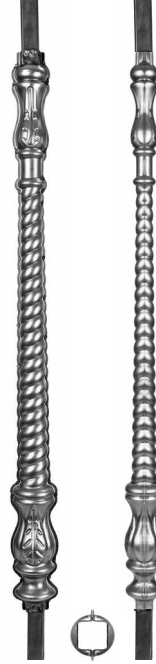

3573
0.70 mm 67x1000 mm
çift-kaynaklı
(double-welded)



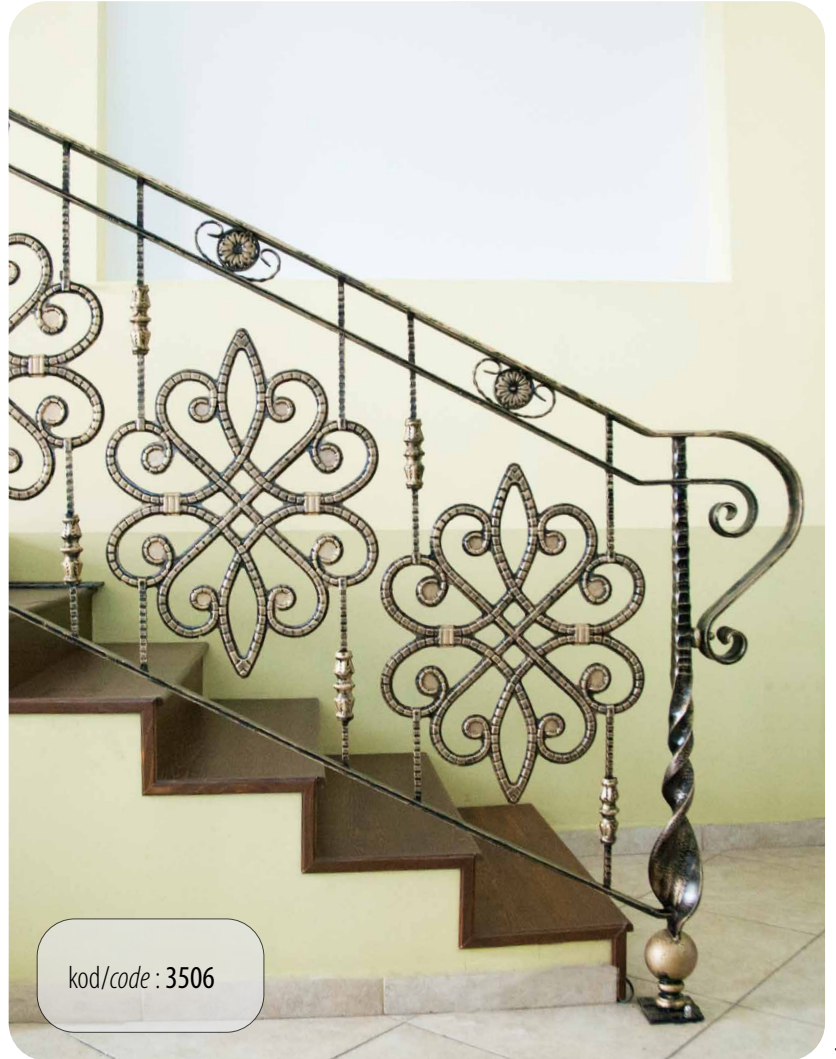
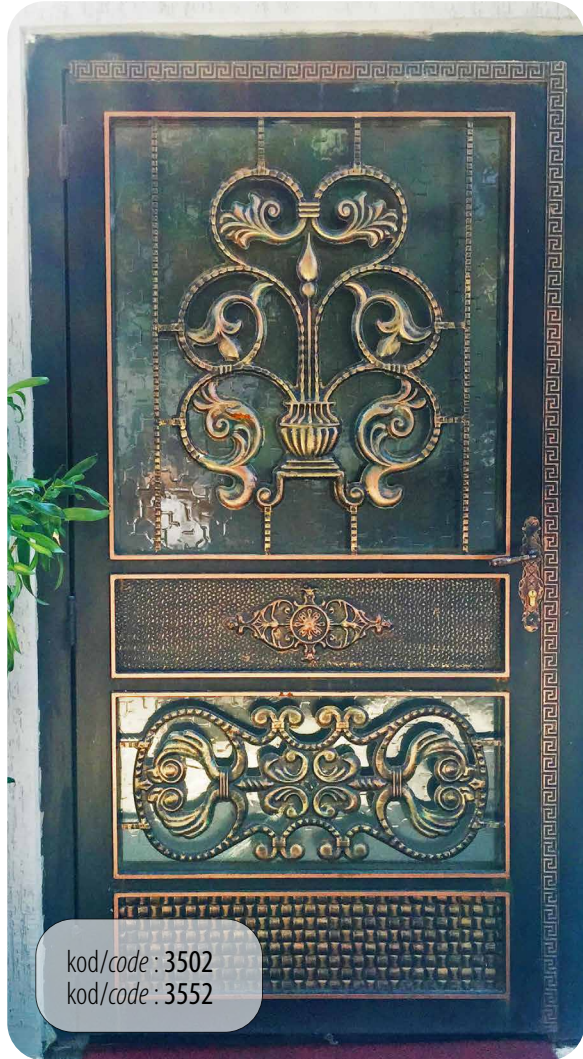
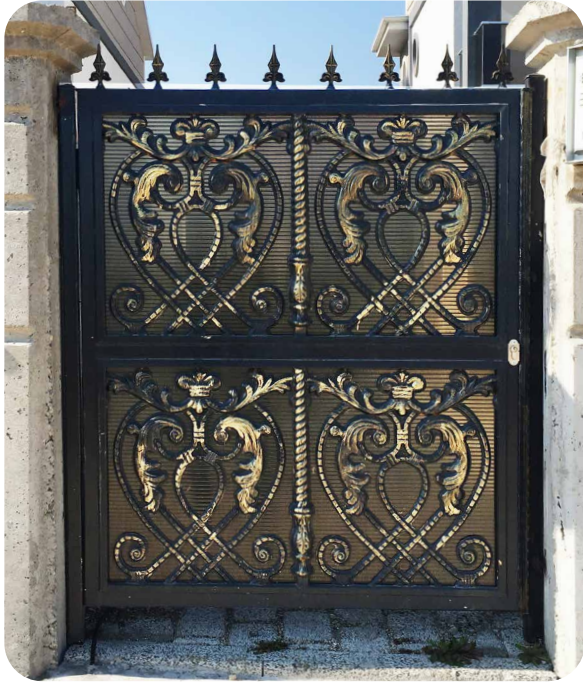

Sac Bordürler - Sheet Frames

3600
80x1000 mm
0.70 mm



3601
84x1000 mm
0.70 mm

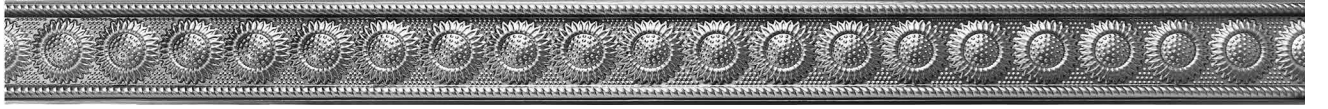

3602
42x1000 mm
0.70 mm



3603
63x1000 mm
0.70 mm



3604
84x1000 mm
0.70 mm



3605
100x1000 mm
0.70 mm



3606
100x1000 mm
0.70 mm

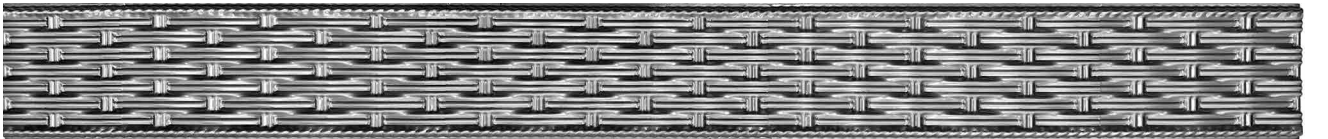

3608
100x1000 mm
0.70 mm

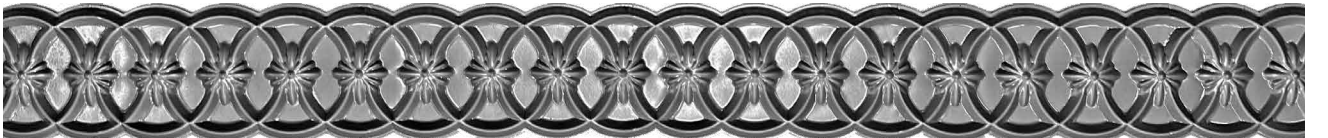

3610
107x1000 mm
0.70 mm



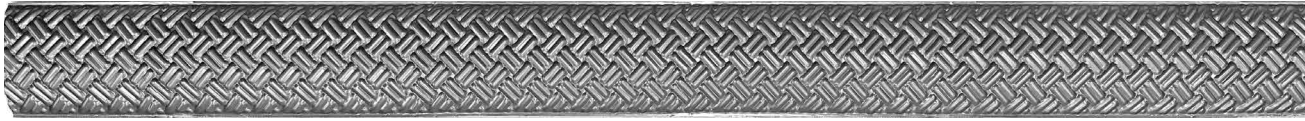

3611
84x1000 mm
0.70 mm



3612
69x1000 mm
0.70 mm



3613
69x1000 mm
0.70 mm



3614
68x1000 mm
0.70 mm



3615
93x1000 mm
0.70 mm



3616
68x1000 mm
0.70 mm

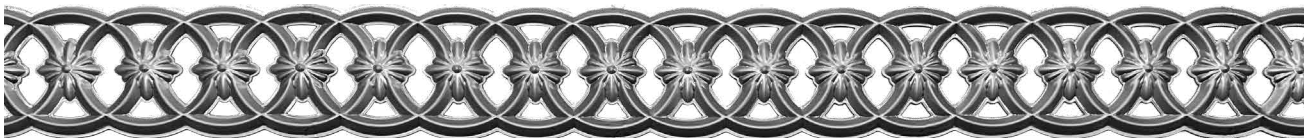

3617
100x1000 mm
0.70 mm

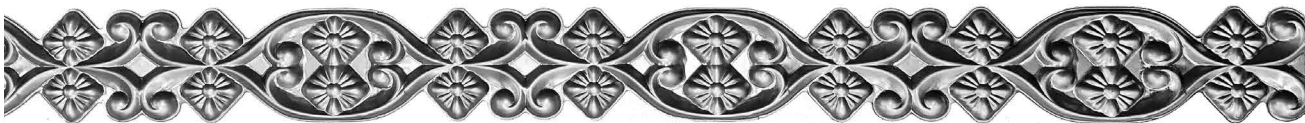

3618
85x1000 mm
0.70 mm



3619
42x1000 mm
0.70 mm



3620
90x1000 mm
0.70 mm

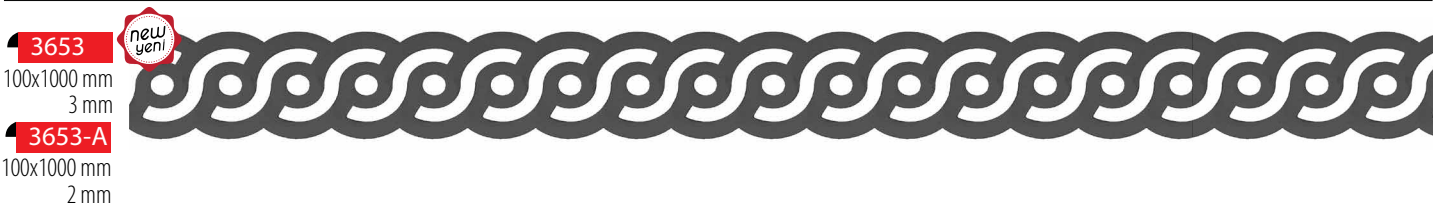
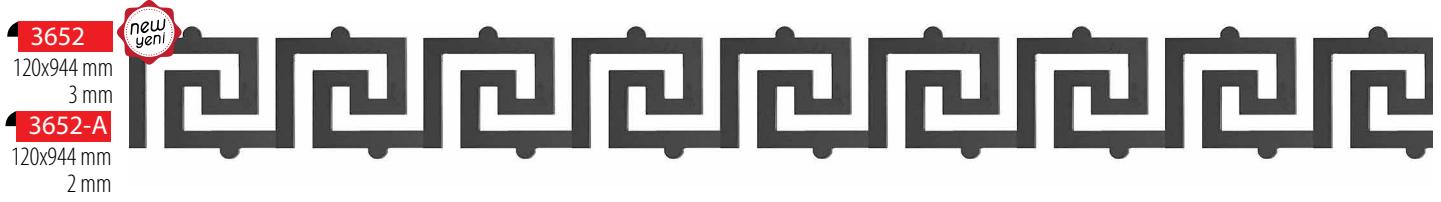
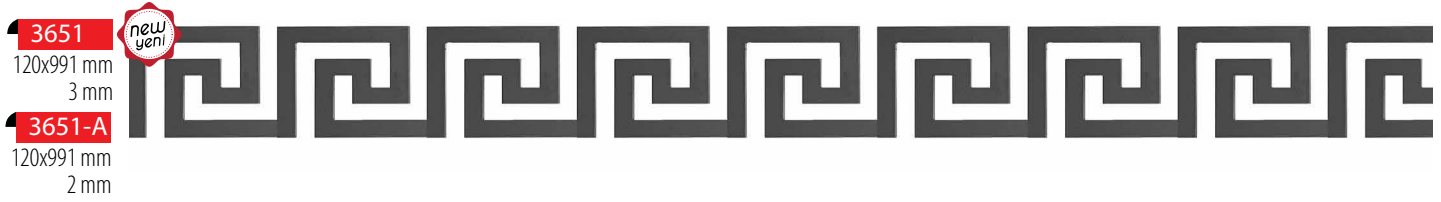
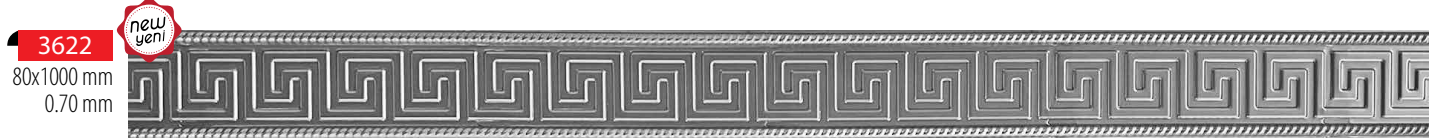

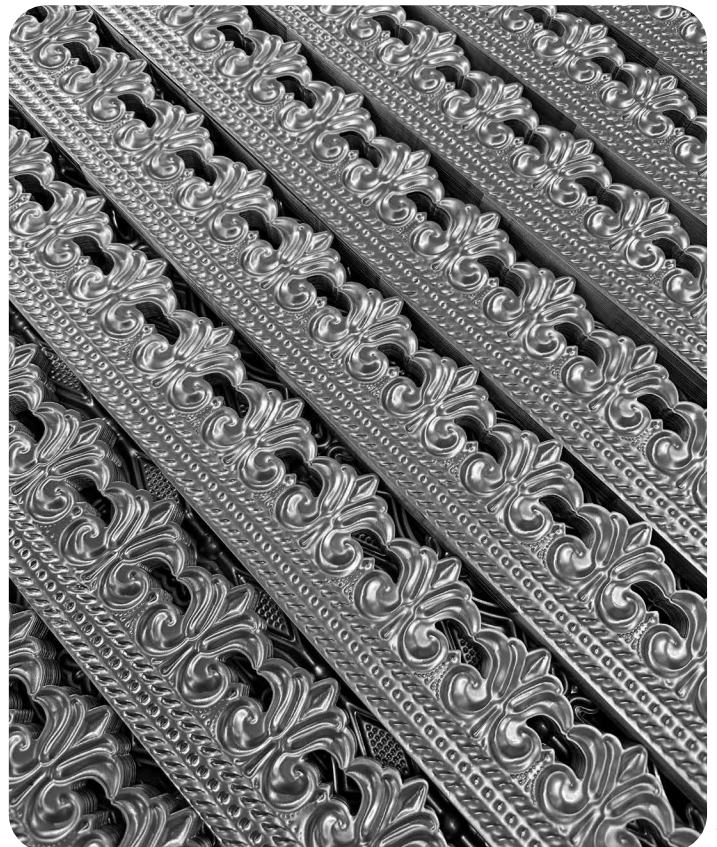
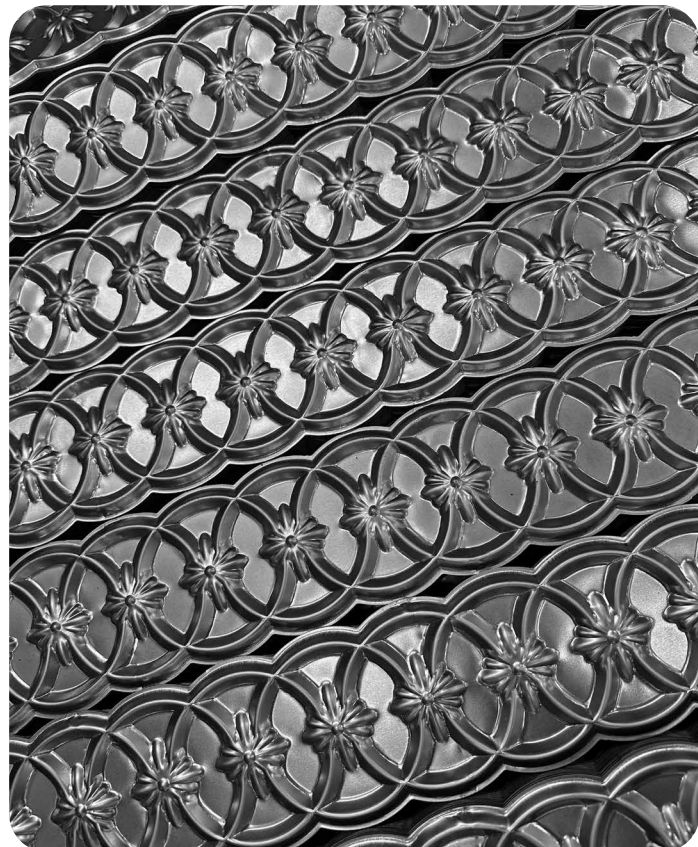
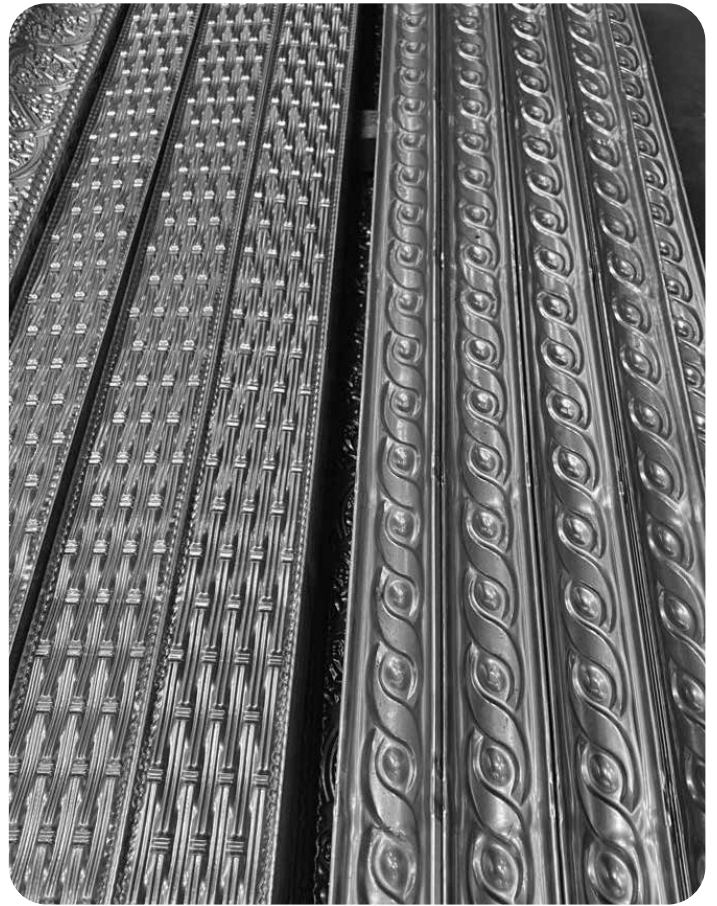

Dekoratif Menteşeler - Decorative Hinges



Kod Code	Ölçü Dimension	Sac Kalınlığı Thickness
3411	250x135 mm	3 mm
3403	383x207 mm	3 mm
3406	493x227 mm	3 mm



Kod Code	Ölçü Dimension	Sac Kalınlığı Thickness
3411-A	250x135 mm	3 mm
3404	383x207 mm	3 mm
3408	493x227 mm	3 mm

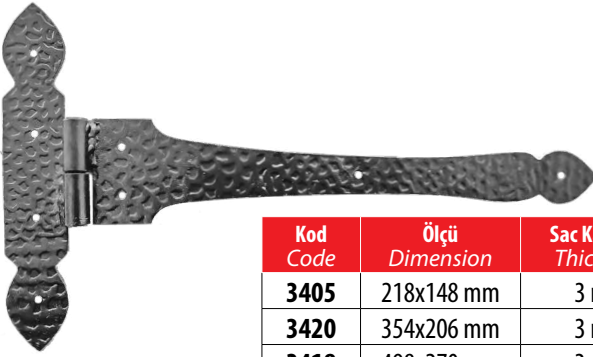

Kod Code	Ölçü Dimension	Sac Kalınlığı Thickness
3405	218x148 mm	3 mm
3420	354x206 mm	3 mm
3418	498x270 mm	3 mm

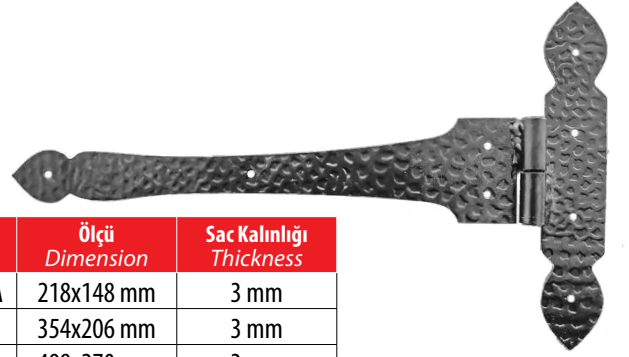

Kod Code	Ölçü Dimension	Sac Kalınlığı Thickness
3405-A	218x148 mm	3 mm
3421	354x206 mm	3 mm
3419	498x270 mm	3 mm



Kod Code	Ölçü Dimension	Sac Kalınlığı Thickness
3412	232x131 mm	3 mm
3409	350x200 mm	3 mm
3416	522x225 mm	3 mm



Kod Code	Ölçü Dimension	Sac Kalınlığı Thickness
3412-A	232x131 mm	3 mm
3410	350x200 mm	3 mm
3417	522x225 mm	3 mm

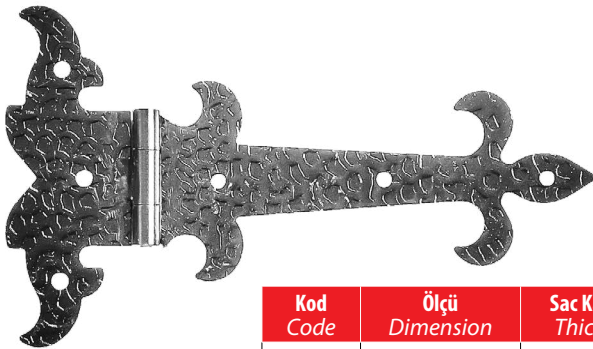

Kod Code	Ölçü Dimension	Sac Kalınlığı Thickness
3442	203x100 mm	3 mm
3439	350x200 mm	3 mm
3443	525x225 mm	3 mm

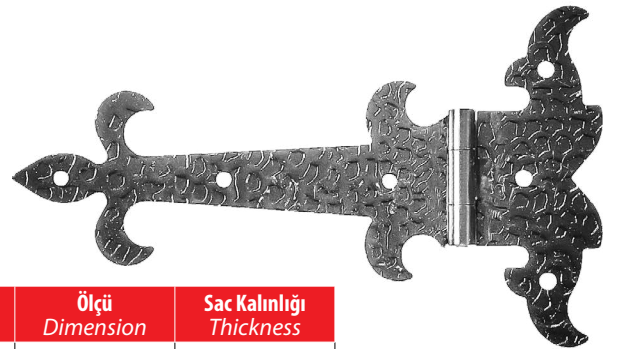

Kod Code	Ölçü Dimension	Sac Kalınlığı Thickness
3442-A	203x100 mm	3 mm
3440	350x200 mm	3 mm
3444	525x225 mm	3 mm

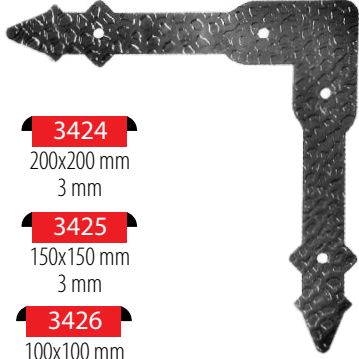

3424
200x200 mm
3 mm

3425
150x150 mm
3 mm

3426
100x100 mm
3 mm

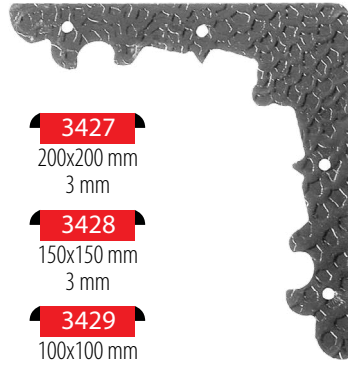

3427
200x200 mm
3 mm

3428
150x150 mm
3 mm

3429
100x100 mm
3 mm

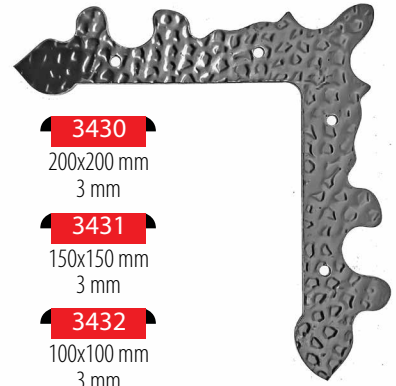

3430
200x200 mm
3 mm

3431
150x150 mm
3 mm

3432
100x100 mm
3 mm

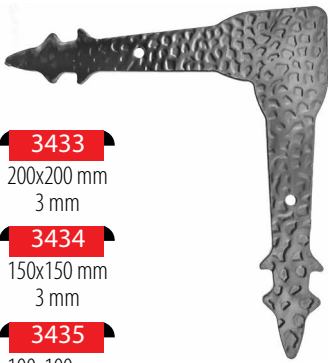

3433
200x200 mm
3 mm

3434
150x150 mm
3 mm

3435
100x100 mm
3 mm

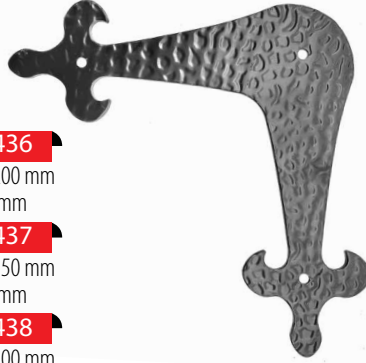

3436
200x200 mm
3 mm

3437
150x150 mm
3 mm

3438
100x100 mm
3 mm



3414
160x185 mm
3 mm

3415
208x250 mm
3 mm



3400
242x168 mm
3 mm



3407
217x93 mm
3 mm



3413
109x168 mm
3 mm



3401
275x165 mm
3 mm



3422
45x143x143 mm
3 mm



3441
125x150 mm
3 mm



3423
282x57 mm
3 mm



3402
70x142 mm
3 mm

Kapı Aynaları - Door Lock Plates

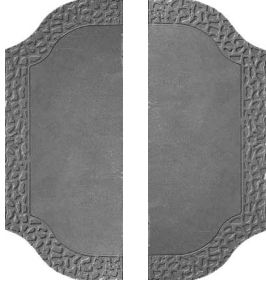

3950
105x265 mm
3 mm

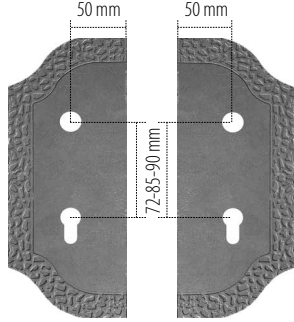

3950-A
105x265 mm
3 mm

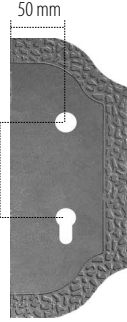

3950-B
105x265 mm
3 mm



3951
105x265 mm
2 mm

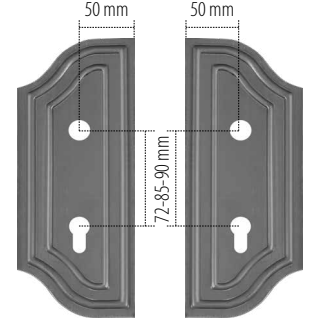

3951-A
105x265 mm
2 mm

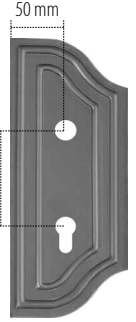

3951-B
105x265 mm
2 mm



3952
155x275 mm
2 mm

3953
155x275 mm
2 mm

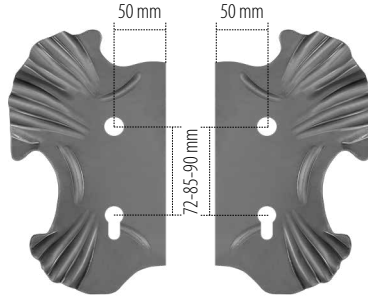

3952-A
155x275 mm
2 mm

3953-A
155x275 mm
2 mm



3954
150x275 mm
2 mm

3955
150x275 mm
2 mm

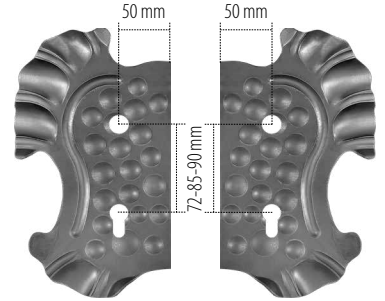

3954-A
150x275 mm
2 mm

3955-A
150x275 mm
2 mm

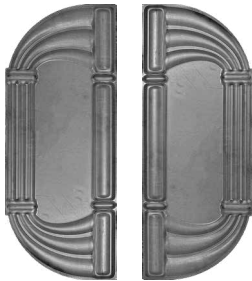

3956
120x315 mm
2 mm

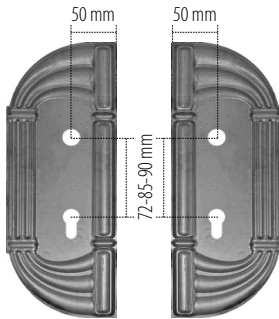

3956-A
120x315 mm
2 mm

3956-B
120x315 mm
2 mm

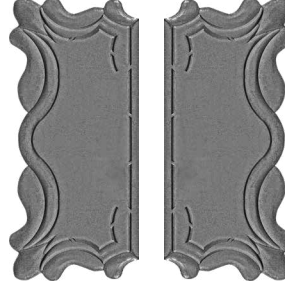

3957
135x305 mm
3 mm

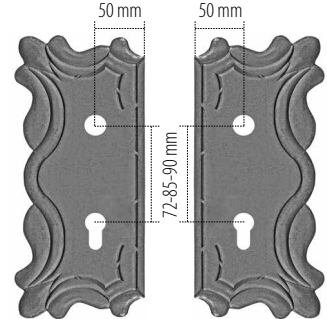

3957-A
135x305 mm
3 mm

3957-B
135x305 mm
3 mm

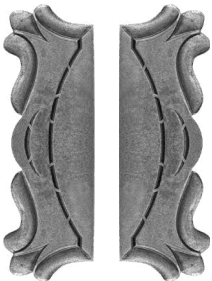

3958
90x295 mm
3 mm

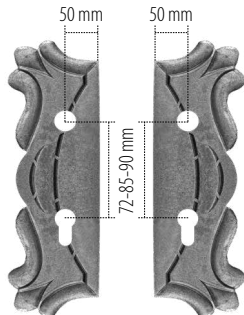

3958-A
90x295 mm
3 mm

3958-B
90x295 mm
3 mm

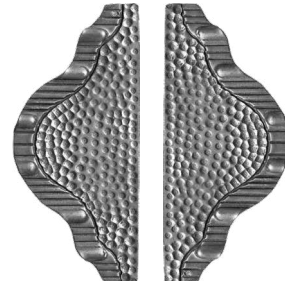

3959
120x290 mm
3 mm

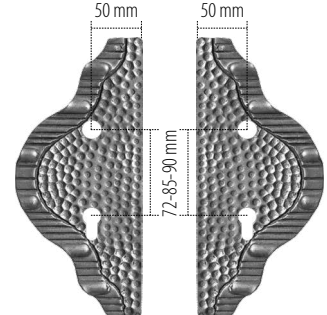

3959-A
120x290 mm
3 mm

3959-B
120x290 mm
3 mm

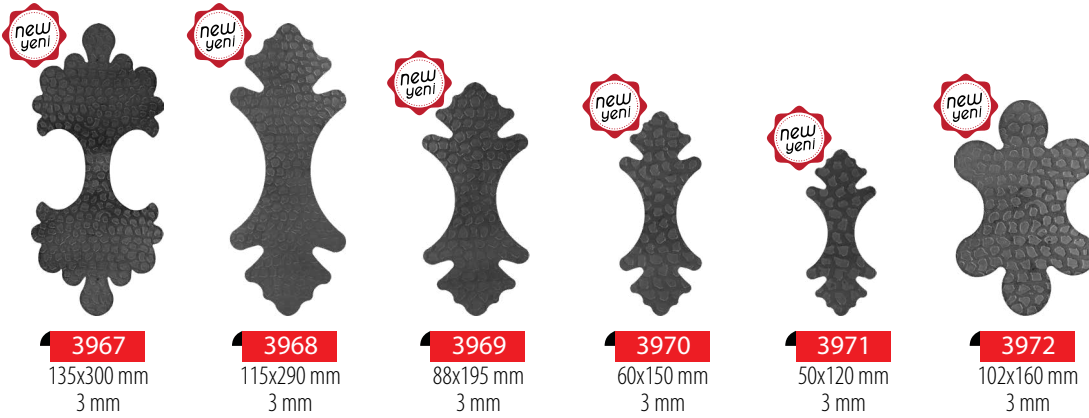
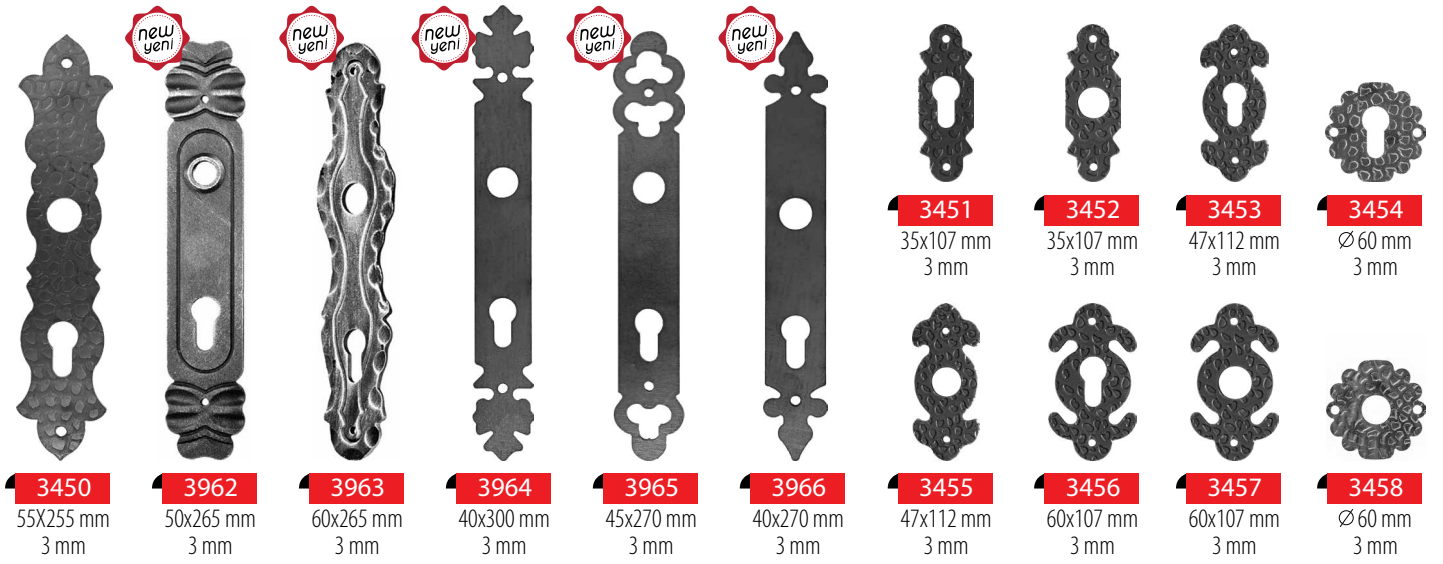
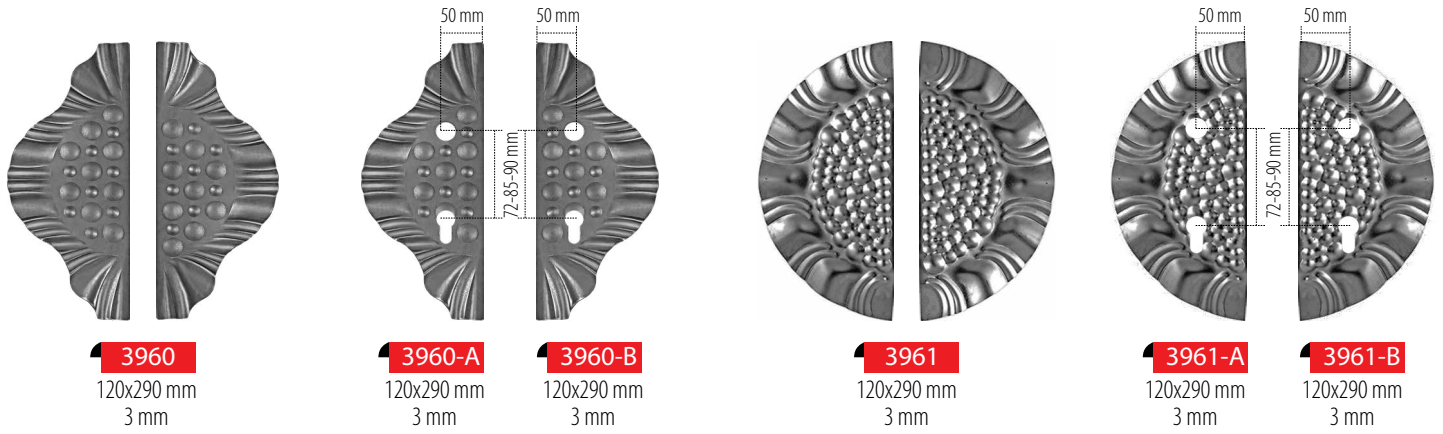

Kapı Tokmakları - Door Knockers



Dekoratif Kapı Kolları - Decorative Door Knobs



2763
Ø75 mm
55 mm



2785
Ø65 mm
60 mm



2786
Ø65 mm
70 mm



2758
95x235 mm



2759
80x255 mm



2790
75x675 mm



2787
110x60 mm



2788
110x75 mm



2789
110x70 mm



2760
80x260 mm



2761
110x275 mm



2762
110x360 mm



2776
12x12 mm
90x280 mm



2777
20x10 mm
115x300 mm



2778
12x12 mm
50x210 mm



2791
□12 mm
55x240 mm



2792
□12 mm
45x245 mm

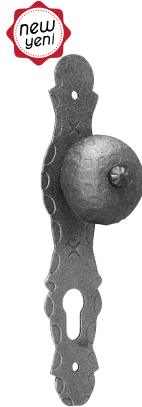

2793
60x240 mm

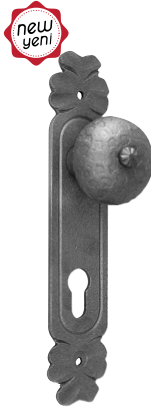

2794
65x245 mm



2795
75x390 mm



2796
100x280 mm



2797
100x280 mm

Dekoratif Kapı Kolları - Decorative Door Handles



2767
85x160 mm



2768
85x125 mm

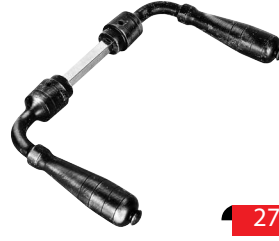

2769
80x120 mm



2770
85x145 mm



2771
80x140 mm



2772
70x130 mm



2773
55x145 mm



2774
60x130 mm



2775
75x140 mm



2779
70x150 mm



2780
70x150 mm

Kollu Kapı Aynaları - Door Lock Plates with Handle



3980
155x275 mm
3 mm



3981
155x275 mm
3 mm



3982
160x290 mm
2 mm



3983
160x290 mm
2 mm



4113
8x90 mm



4114
8x100 mm



4115
8x120 mm

Kapı Kolu Milleri - Door Handle Shafts

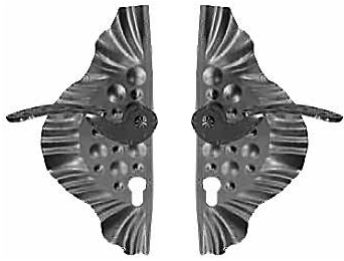

3984
120x290 mm
3 mm



3985
120x290 mm
3 mm



3986
57x260 mm
3 mm



3987
57x260 mm
3 mm



3988
46x260 mm
3 mm



3989
46x260 mm
3 mm

Yaylı Sürgüler - Padlock Bolts

 Yaylı Sürgü
 Padlock Bolt with Spring

Kod Code	Ölçü Dimension	Kg.	Kutu Adedi Pcs in a Box	Kod Code	Ölçü Dimension	Kg.	Kutu Adedi Pcs in a Box
4100	22x3x120 mm	0.22	45	4106	30x4x400 mm	0.82	20
4101	26x3x150 mm	0.28	25	4107	30x4x450 mm	0.91	20
4102	30x4x200 mm	0.50	20	4108	30x4x500 mm	1.00	20
4103	30x4x250 mm	0.56	20	4109	30x4x550 mm	1.10	20
4104	30x4x300 mm	0.64	20	4110	30x4x600 mm	1.18	20
4105	30x4x350 mm	0.74	20	4112	30x4x1000 mm	2.20	20

new yeni

 Ekonomik Yaylı Sürgü
 Eco-Padlock Bolt with Spring

Kod Code	Ölçü Dimension	Kg.	Kutu Adedi Pcs in a Box
4116	30x2.5x130 mm	0.14	40
4117	30x2.5x150 mm	0.20	30
4118	30x2.5x200 mm	0.24	25

new yeni

 Demirci Sürgüsü
 Sliding Bolt

Kod Code	Ölçü Dimension	Kg.	Kutu Adedi Pcs in a Box
4119	40x85 mm	0.16	50
4120	40x120 mm	0.23	45

Kepli ve Civatalı Makaralar - Wheel whit support 2 bearings (V+U) form

Kepli-Çift Rulmanlı Makara



Kod Code	Ölçü Dimension	Kg.	Kutu Adedi Pcs in a Box
4130	Ø40x20 mm	0.16	12
4131	Ø50x20 mm	0.27	12
4132	Ø60x28 mm	0.53	12
4133	Ø70x28 mm	0.70	12
4134	Ø80x28 mm	1.00	10
4135	Ø90x28 mm	1.30	8
4136	Ø100x28 mm	1.60	8



Pimli-Çift Rulmanlı Yedek Makara

Kod Code	Ölçü Dimension	Kg.	Kutu Adedi Pcs in a Box
4140	Ø40x20 mm	0.11	12
4141	Ø50x20 mm	0.18	12
4142	Ø60x28 mm	0.33	12
4143	Ø70x28 mm	0.50	12
4144	Ø80x28 mm	0.69	8
4145	Ø90x28 mm	0.96	8
4146	Ø100x28 mm	1.22	8

Denge Sacı ve Makaralar - Guides & Guide Plates

 Denge Makarası (civatalı)
 Guides & Guide Plates (with pin bolt)

Kod Code	Ölçü Dimension	Kg.	Kutu Adedi Pcs in a Box
4170	Ø25x38 mm	0.09	20
4171	Ø35x38 mm	0.12	20
4172	Ø38x59 mm	0.16	15

 Metal Denge Makarası Pimli/Civatalı
 Metal Guide With Ball Bearing

Kod Code	Ölçü Dimension	Kg.	Kutu Adedi Pcs in a Box
4175	Ø30x38 mm (pimli)	0.21	60
4176	Ø30x38 mm M12 (civatalı)	0.25	60

 Denge Makarası Pimli
 Plastic Guide with Iron Pin (For Welding)

Kod Code	Ölçü Dimension	Kg.	Kutu Adedi Pcs in a Box
4173	Ø35x38 mm	0.10	100
4174	Ø38x59 mm	0.14	100

 Denge Makarası-Pro
 Plastic Guide-Pro-With Screw

Kod Code	Ölçü Dimension	Kg.	Kutu Adedi Pcs in a Box
4177	29x40 mm M12	0.11	20
4178	39x49 mm M12	0.15	15
4179	39x56 mm M14	0.24	100



Denge Makarası - Kepli
Guide With Support

Kod Code	Ölçü Dimension	Kg.	Kutu Adedi Pcs in a Box
4180	21x40 mm Denge Guide With Support	0.10	40



2'li Büyük Denge Seti
Single Plate with 2 Guides (M14)

Kod Code	Ölçü Dimension	Kg.	Kutu Adedi Pcs in a Box
4193	14-92 mm	0.82	25



Bayrak Makarası
Guide With Support

Kod Code	Ölçü Dimension	Kg.	Kutu Adedi Pcs in a Box
4181	23x40 mm Bayrak Guide With Support	0.10	40



2'li Denge Seti-Eko
Guide Set With 2 Guides

Kod Code	Ölçü Dimension	Kg.	Kutu Adedi Pcs in a Box
4198	22-87 mm	0.41	25



Kapı Üst Mandalı

Kod Code	Ölçü Dimension	Kg.	Kutu Adedi Pcs in a Box
4182	30x30 mm	0.17	25
4183	40x40 mm	0.18	25



2'li Büyük Denge Sacı
Big Single Metal Plate

Kod Code	Ölçü Dimension	Kg.	Kutu Adedi Pcs in a Box
4196-A	14-92 mm	0.34	25



Ayarlı Çarpma Mandalı
Adjustable Transom Latch

Kod Code	Ölçü Dimension	Kg.	Kutu Adedi Pcs in a Box
4185	48x56 mm	0.07	50



2'li Ayarlı Denge Sacı
Single Adjustable Plate Without Guides

Kod Code	Ölçü Dimension	Kg.	Kutu Adedi Pcs in a Box
4194	22-72 mm	0.48	20



Tekli Denge Seti
Single Plate with 1 Guide

Kod Code	Ölçü Dimension	Kg.	Kutu Adedi Pcs in a Box
4192	Ø35x38 mm	0.26	25

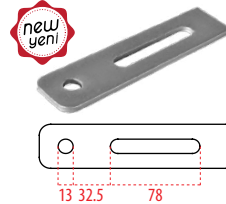

Denge Sacı
Guide Plate

Kod Code	Ölçü Dimension	Kg.	Kutu Adedi Pcs in a Box
4199	40x165x5 mm	0.22	20



Tekli Denge Seti
Double Adjustable Plate Without Guides

Kod Code	Ölçü Dimension	Kg.	Kutu Adedi Pcs in a Box
4197	Ø40 mm	0.40	50



4'lü Ayarlı Denge Seti
Double Adjustable Plate With L Guides (M12)

Kod Code	Ölçü Dimension	Kg.	Kutu Adedi Pcs in a Box
4195	35-72 mm	2.30	10



2'li Denge Seti
Single Plate with 2 Guides

Kod Code	Ölçü Dimension	Kg.	Kutu Adedi Pcs in a Box
4190	20-78 mm	0.47	25



4'lü Ayarlı Denge Sacı
Double Adjustable Plate Without Guides

Kod Code	Ölçü Dimension	Kg.	Kutu Adedi Pcs in a Box
4196	35-72 mm	1.60	6



2'li Metal Denge Seti
Single Metal Plate with 2 Guides

Kod Code	Ölçü Dimension	Kg.	Kutu Adedi Pcs in a Box
4191	20-78 mm	0.65	25



Uzun Denge Seti - Ø40 mm
Guide Set for Oval Gates (Ø40 mm)

Kod Code	Ölçü Dimension	Kg.	Kutu Adedi Pcs in a Box
4202	Ø40x300 mm	0.75	20
4203	Ø40x400 mm	0.90	20
4204	Ø40x500 mm	1.05	20

Mil Mentşeler - Hinges
Standart Mil Mentşe
Standard Hinge

Kod Code	Ölçü Dimension	Kg.	Kutu Adedi Pcs in a Box
4205	Ø10x50 mm	0.030	60
4206	Ø12x55 mm	0.044	60
4207	Ø14x60 mm	0.068	50
4208	Ø16x70 mm	0.110	40
4209	Ø18x80 mm	0.115	28
4210	Ø20x85 mm	0.200	24
4211	Ø22x90 mm	0.260	20
4212	Ø24x100 mm	0.345	15
4213	Ø26x110 mm	0.445	20
4214	Ø30x150 mm	0.820	30

Bilyalı Uzun Boy Mentşe
Hinge with Ball- Long Type

Kod Code	Ölçü Dimension	Kg.	Kutu Adedi Pcs in a Box
4222	Ø20x200 mm	0.59	24
4223	Ø24x200 mm	0.71	20
4224	Ø26x200 mm	0.83	18
4225	Ø30x200 mm	1.10	14

Bilyalı Mentşe
Hinge with Ball Holed

Kod Code	Ölçü Dimension	Kg.	Kutu Adedi Pcs in a Box
4216	Ø16x120 mm	0.17	30
4217	Ø16x140 mm	0.20	30
4218	Ø18x120 mm	0.22	20
4219	Ø20x120 mm	0.27	20
4220	Ø22x120 mm	0.33	20
4221	Ø24x120 mm	0.40	15

Ferforje Mentşeler
Decorative Hinge with Ball

Kod Code	Ölçü Dimension	Kg.	Kutu Adedi Pcs in a Box
4226	Ø16x125 mm	0.17	30
4227	Ø18x135 mm	0.23	24
4228	Ø20x150 mm	0.31	22
4229	Ø22x160 mm	0.41	24
4230	Ø24x180 mm	0.55	20
4231	Ø26x185 mm	0.67	20
4232	Ø30x190 mm	0.90	20

Kanatlı Mentşeler - Side Wing Hinges
Yaprak Mentşeler
Hinge with 2 wings

Kod Code	Ölçü Dimension	Kg.	Kutu Adedi Pcs in a Box
4233	40x54x4 mm	0.15	60
4234	50x85x4 mm	0.20	20
4235	60x85x4 mm	0.24	20
4236	70x85x4 mm	0.30	34

Yandan Tek Sac 2 Uzun Kanat
Hinge Side Single Leaf 2 Long Wings

Kod Code	Ölçü Dimension	Kg.	Kutu Adedi Pcs in a Box
4246	Ø25x162x4 mm	0.720	20
4247	Ø30x162x4 mm	0.920	20

Yandan Tek Sac 2 Kanat
Hinge Side Single Leaf 2 Wings

Kod Code	Ölçü Dimension	Kg.	Kutu Adedi Pcs in a Box
4237	Ø12x60x2,5 mm	0.069	50
4238	Ø14x66x2,5 mm	0.098	40
4239	Ø16x70x3 mm	0.135	40
4240	Ø18x76x3 mm	0.175	40
4241	Ø20x82x3 mm	0.225	30
4242	Ø25x112x4 mm	0.480	20
4243	Ø30x112x4 mm	0.640	20

Yandan Tek Sac 3 Kanat
Hinge Side Single Leaf 3 Wings

Kod Code	Ölçü Dimension	Kg.	Kutu Adedi Pcs in a Box
4248	Ø25x164x4 mm	0.720	20
4249	Ø30x164x4 mm	0.920	20

Yandan Tek Sac 4 Kanat
Hinge Side Single Leaf 4 Wings

Kod Code	Ölçü Dimension	Kg.	Kutu Adedi Pcs in a Box
4244	Ø25x166x4 mm	0.720	20
4245	Ø30x166x4 mm	0.920	20

Yandan Çift Saclı Mentşeler - Hinge Center Double Leaf

Yandan Çift Sac 2 Kanat
Hinge With Angle Leaf 2 Wings

Kod Code	Ölçü Dimension	Kg.	Kutu Adedi Pcs in a Box
4250	Ø12x60x2.5 mm	0.069	50
4251	Ø14x66x2.5 mm	0.092	40
4252	Ø16x70x3 mm	0.132	40
4253	Ø18x76x3 mm	0.169	40
4254	Ø20x82x3 mm	0.222	30
4255	Ø25x112x4 mm	0.490	20
4256	Ø30x112x4 mm	0.645	20

Yandan Çift Sac 2 Uzun Kanat
Hinge Side Double Leaf 2 Long Wings

Kod Code	Ölçü Dimension	Kg.	Kutu Adedi Pcs in a Box
4257	Ø25x162x4 mm	0.710	20
4258	Ø30x162x4 mm	0.930	20

Yandan Çift Sac 3 Kanat
Hinge With Angle Leaf 3 Wings

Kod Code	Ölçü Dimension	Kg.	Kutu Adedi Pcs in a Box
4259	Ø25x164x4 mm	0.720	20
4260	Ø30x164x4 mm	0.930	20

Yandan Çift Sac 4 Kanat
Hinge With Angle Leaf 4 Wings

Kod Code	Ölçü Dimension	Kg.	Kutu Adedi Pcs in a Box
4261	Ø25x166x4 mm	0.720	20
4262	Ø30x166x4 mm	0.930	20

Merkezden Açılır Mentşeler - Center Opening Hinges

Merkezden Açılır 2 Kanat
Center Opening with 2 Wings

Kod Code	Ölçü Dimension	Kg.	Kutu Adedi Pcs in a Box
4263	Ø25x112x4 mm	0.520	15
4264	Ø30x112x4 mm	0.625	15

Merkezden Açılır 2 Uzun Kanat
Center Opening with 2 Long Wings

Kod Code	Ölçü Dimension	Kg.	Kutu Adedi Pcs in a Box
4265	Ø25x162x4 mm	0.750	15
4266	Ø30x162x4 mm	0.920	15

Merkezden Açılır 3 Kanat
Center Opening with 3 Wings

Kod Code	Ölçü Dimension	Kg.	Kutu Adedi Pcs in a Box
4267	Ø25x166x4 mm	0.750	15
4268	Ø30x166x4 mm	0.910	15

Merkezden Açılır 4 Kanat
Center Opening with 4 Wings

Kod Code	Ölçü Dimension	Kg.	Kutu Adedi Pcs in a Box
4269	Ø25x164x4 mm	0.750	15
4270	Ø30x164x4 mm	0.910	15

Pencere Mandalı - Window Latch

Pencere Mandalı
Window Latch

Kod Code	Ölçü Dimension	Kg.	Kutu Adedi Pcs in a Box
4372	2x63x80 mm	0.06	50

Damla Mentşe - Drop Profile Hinge

Damla Mentşe
Drop Profile Hinge

Kod Code	Ölçü Dimension	Kg.	Kutu Adedi Pcs in a Box
4373	Ø14x92 mm	0.10	45
4374	Ø18x114 mm	0.21	30
4375	Ø20x137 mm	0.32	30
4376	Ø25x148 mm	0.50	20

Profesyonel Makara Grubu - Wheels
1 Rulman Dış Sac V Kanal
Wheel With Side Support 1 Bearing (V) Form

Kod Code	Ölçü Dimension	Kg.	Kutu Adedi Pcs in a Box
4271	Ø60x17 mm	0.30	8
4272	Ø70x17 mm	0.42	8
4273	Ø80x20 mm	0.71	6
4274	Ø100x20 mm	1.21	4
4275	Ø120x22 mm	1.89	6

2 Rulman Dış Sac V Kanal
Wheel With Side Support 2 Bearings (V) Form

Kod Code	Ölçü Dimension	Kg.	Kutu Adedi Pcs in a Box
4289	Ø60x27 mm	0.40	12
4290	Ø70x27 mm	0.61	12
4291	Ø80x30 mm	0.91	8
4292	Ø100x30 mm	1.61	8
4293	Ø120x35 mm	2.66	4

1 Rulman Dış Sac U Kanal
Wheel With Side Support 1 Bearing (U) Form

Kod Code	Ölçü Dimension	Kg.	Kutu Adedi Pcs in a Box
4277	Ø60x17 mm	0.30	8
4278	Ø70x17 mm	0.42	8
4279	Ø80x20 mm	0.71	6
4280	Ø100x20 mm	1.21	4
4281	Ø120x22 mm	1.89	6

2 Rulman Dış Sac U Kanal
Wheel With Side Support 2 Bearings (U) Form

Kod Code	Ölçü Dimension	Kg.	Kutu Adedi Pcs in a Box
4295	Ø60x27 mm	0.40	12
4296	Ø70x27 mm	0.61	12
4297	Ø80x30 mm	0.91	8
4298	Ø100x30 mm	1.61	8
4299	Ø120x35 mm	2.66	4

1 Rulman Dış Sac □ Kanal
Wheel With Side Support 1 Bearing □ Form

Kod Code	Ölçü Dimension	Kg.	Kutu Adedi Pcs in a Box
4283	Ø60x17 mm	0.30	8
4284	Ø70x17 mm	0.42	8
4285	Ø80x20 mm	0.71	6
4286	Ø100x20 mm	1.21	4
4287	Ø120x22 mm	1.89	6

2 Rulman Dış Sac □ Kanal
Wheel With Side Support 2 Bearings □ Form

Kod Code	Ölçü Dimension	Kg.	Kutu Adedi Pcs in a Box
4301	Ø60x27 mm	0.40	12
4302	Ø70x27 mm	0.61	12
4303	Ø80x30 mm	0.91	8
4304	Ø100x30 mm	1.61	8
4305	Ø120x35 mm	2.66	4

1 Rulman Civata V Kanal
Wheel With Screw 1 Bearing (V) Form

Kod Code	Ölçü Dimension	Kg.	Kutu Adedi Pcs in a Box
4307	Ø60x17 mm	0.30	8
4308	Ø70x17 mm	0.42	8
4309	Ø80x20 mm	0.71	6
4310	Ø100x20 mm	1.21	4
4311	Ø120x22 mm	1.89	6

2 Rulman Civata V Kanal
Wheel With Screw 2 Bearings (V) Form

Kod Code	Ölçü Dimension	Kg.	Kutu Adedi Pcs in a Box
4325	Ø60x27 mm	0.40	12
4326	Ø70x27 mm	0.61	12
4327	Ø80x30 mm	0.91	8
4328	Ø100x30 mm	1.61	8
4329	Ø120x35 mm	2.66	4

1 Rulman Civata U Kanal
Wheel With Screw 1 Bearing (U) Form

Kod Code	Ölçü Dimension	Kg.	Kutu Adedi Pcs in a Box
4313	Ø60x17 mm	0.30	8
4314	Ø70x17 mm	0.42	8
4315	Ø80x20 mm	0.71	6
4316	Ø100x20 mm	1.21	4
4317	Ø120x22 mm	1.89	6

2 Rulman Civata U Kanal
Wheel With Screw 2 Bearings (U) Form

Kod Code	Ölçü Dimension	Kg.	Kutu Adedi Pcs in a Box
4331	Ø60x27 mm	0.40	12
4332	Ø70x27 mm	0.61	12
4333	Ø80x30 mm	0.91	8
4334	Ø100x30 mm	1.61	8
4335	Ø120x35 mm	2.66	4

1 Rulman Civata □ Kanal
Wheel With Screw 1 Bearing □ Form

Kod Code	Ölçü Dimension	Kg.	Kutu Adedi Pcs in a Box
4319	Ø60x17 mm	0.30	8
4320	Ø70x17 mm	0.42	8
4321	Ø80x20 mm	0.71	6
4322	Ø100x20 mm	1.21	4
4323	Ø120x22 mm	1.89	6

2 Rulman Civata □ Kanal
Wheel With Screw 2 Bearings □ Form

Kod Code	Ölçü Dimension	Kg.	Kutu Adedi Pcs in a Box
4337	Ø60x27 mm	0.40	12
4338	Ø70x27 mm	0.61	12
4339	Ø80x30 mm	0.91	8
4340	Ø100x30 mm	1.61	8
4341	Ø120x35 mm	2.66	4

Profesyonel Makara Grubu - Wheel



1 Rulman Kepli V Kanal
Wheel With Support 1 Bearing (V) Form

Kod Code	Ölçü Dimension	Kg.	Kutu Adedi Pcs in a Box
4343	Ø60x17 mm	0.43	12
4343-A	Ø70x17 mm	0.52	12
4344	Ø80x20 mm	0.87	8
4345	Ø100x20 mm	1.30	8



2 Rulman Trolley V Kanal
Trolley- 2 Bearings (V) Form

Kod Code	Ölçü Dimension	Kg.	Kutu Adedi Pcs in a Box
4360	Ø100x30 mm	4.15	2
4361	Ø120x35 mm	7.40	2



1 Rulman Kepli U Kanal
Wheel With Support 1 Bearing (U) Form

Kod Code	Ölçü Dimension	Kg.	Kutu Adedi Pcs in a Box
4346	Ø60x17 mm	0.43	12
4347	Ø70x17 mm	0.52	12
4348	Ø80x20 mm	0.87	8
4349	Ø100x20 mm	1.30	8



2 Rulman Trolley U Kanal
Trolley- 2 Bearings (U) Form

Kod Code	Ölçü Dimension	Kg.	Kutu Adedi Pcs in a Box
4363	Ø100x30 mm	4.15	2
4364	Ø120x35 mm	7.40	2



1 Rulman Kepli Kanal
Wheel With Support 1 Bearing Form

Kod Code	Ölçü Dimension	Kg.	Kutu Adedi Pcs in a Box
4350	Ø60x17 mm	0.43	12
4351	Ø70x17 mm	0.52	12
4352	Ø80x20 mm	0.87	8
4353	Ø100x20 mm	1.30	8



2 Rulman Trolley Kanal
Trolley- 2 Bearings Form

Kod Code	Ölçü Dimension	Kg.	Kutu Adedi Pcs in a Box
4366	Ø100x30 mm	4.15	2
4367	Ø120x35 mm	7.40	2



1 Rulman Gömme Sac V Kanal
Wheel With Inner Support 1 Bearing (V) Form

Kod Code	Ölçü Dimension	Kg.	Kutu Adedi Pcs in a Box
4354	Ø80x20 mm	0.70	12
4355	Ø90x20 mm	1.00	12
4356	Ø100x20 mm	1.17	12



1 Rulman Gömme Sac Kanal
Wheel With Inner Support 1 Bearing Form

Kod Code	Ölçü Dimension	Kg.	Kutu Adedi Pcs in a Box
4369	Ø80x20 mm	0.70	12
4370	Ø90x20 mm	1.00	12
4371	Ø100x20 mm	1.17	12



1 Rulman Gömme Sac U Kanal
Wheel With Inner Support 1 Bearing (U) Form

Kod Code	Ölçü Dimension	Kg.	Kutu Adedi Pcs in a Box
4357	Ø80x20 mm	0.70	12
4358	Ø90x20 mm	1.00	12
4359	Ø100x20 mm	1.17	12

Özel Makara Grubu - Special Wheels

new
yeni



Oval Kapı Sarhoş Makara-1
Rotating Wheel-1

Kod Code	Ölçü Dimension	Kg.	Kutu Adedi Pcs in a Box
4377	70x28 mm	0.97	18

new
yeni



Oval Kapı Sarhoş Makara-2
Rotating Wheel-2

Kod Code	Ölçü Dimension	Kg.	Kutu Adedi Pcs in a Box
4378	80x20 mm	1.45	18

Özel Menteşe Grubu - Special Guides



Ayarlanabilir Cıvatalı Menteşe
Adjustable Upper Hinges with Bolt

Kod Code	Ölçü Dimension	Kg.	Kutu Adedi Pcs in a Box
4379	16x110 mm	0.50	24
4380	20x110 mm	0.53	24



Ayarlanabilir Özel Somunlu Menteşe
Adjustable Upper Hinges with Special Nut

Kod Code	Ölçü Dimension	Kg.	Kutu Adedi Pcs in a Box
4381	16x75 mm	0.43	24
4382	20x75 mm	0.46	24

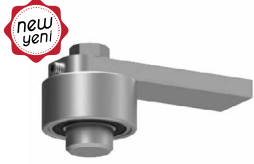

Uzun Kapılar için Rulmanlı Menteşe-Üst
Pivot Hinge with Ball Bearing-Upper

Kod Code	Ölçü Dimension	Kg.	Kutu Adedi Pcs in a Box
4383	küçük (small)	0.28	12
4384	büyük (big)	0.64	12



Uzun Kapılar için Rulmanlı Menteşe-Alt
Pivot Hinge with Ball Bearing-Lower

Kod Code	Ölçü Dimension	Kg.	Kutu Adedi Pcs in a Box
4385	küçük (small)	0.42	12
4386	büyük (big)	1.18	12



Oval Kapı Menteşesi
Radius Sliding Gate Hinge

Kod Code	Ölçü Dimension	Kg.	Kutu Adedi Pcs in a Box
4387	58x5 mm	0.45	50

Kuş Koruma Profilleri - Bird Spikes for Gate and Fence

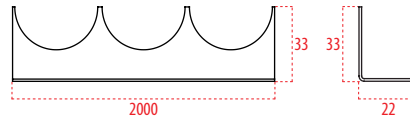

Kuş Koruma Profili-1 (bükümlü)
Bird Spikes for Gate and Fence-1 (bent)

Kod Code	Kalınlık Thickness	Ölçü Dimension	Kg
8083	2 mm	33x22x2000 mm	1.20

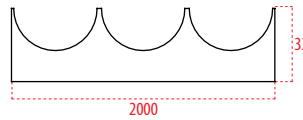
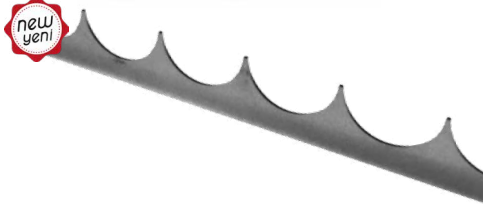

Kuş Koruma Profili-2
Bird Spikes for Gate and Fence-2

Kod Code	Kalınlık Thickness	Ölçü Dimension	Kg
8084	2 mm	33x2000 mm	0.59

Motor Montaj Profili - Garage Motor Mounting Bracket

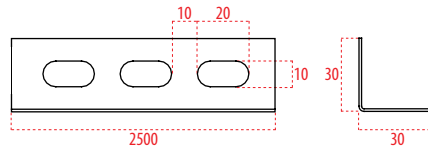
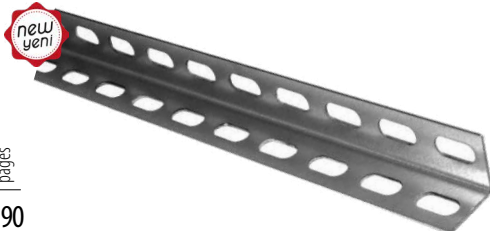

Motor Montaj Rayı
Garage Motor Mounting Bracket

Kod Code	Kalınlık Thickness	Ölçü Dimension	Kg
8085	2 mm	30x30x2500 mm	1.78

sürgü kapı rayları - *sliding gate tracks*
kapı stoperi ve kapı emniyet aparatı - *door stopper and gate latch*
montaj aksesuarları - *fixing elements*

Sürgü Kapı Klavuz Rayları - *Sliding Gate Tracks*

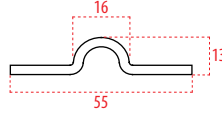

Sürgü Kapı Klavuz Rayı-1 (Tek Rulmanlı Makaralara Uygun)
Sliding Gate Track-1 (suitable for 1 bearing wheels)

Kod Code	Kalınlık Thickness	Uzunluk Length	Kg	Kutu Adedi Pcs in a Box
8086	3 mm	3000 mm	4.00	20

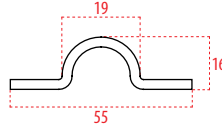
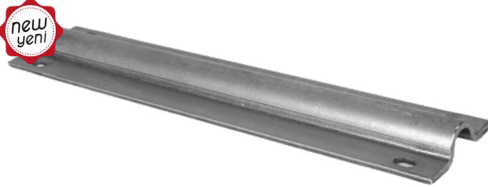

Sürgü Kapı Klavuz Rayı-2 (Çift Rulmanlı Makaralara Uygun)
Sliding Gate Track-2 (suitable for 2 bearing wheels)

Kod Code	Kalınlık Thickness	Uzunluk Length	Kg	Kutu Adedi Pcs in a Box
8087	3 mm	3000 mm	4.80	20

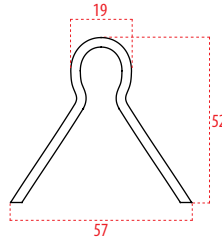

Sürgü Kapı Klavuz Rayı-3
Sliding Gate Track-3 (cement fixing)

Kod Code	Kalınlık Thickness	Uzunluk Length	Kg	Kutu Adedi Pcs in a Box
8088	3 mm	3000 mm	3.90	20

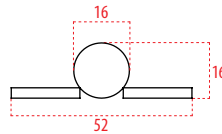

Sürgü Kapı Klavuz Rayı-4
Sliding Gate Track-4 (radius curved)

Kod Code	Kalınlık Thickness	Uzunluk Length	Kg	Kutu Adedi Pcs in a Box
8089	3 mm	90°	1.95	20

Kapı Stoperi - *Door Stopper*



Kapı Stoperi
Door Stopper

Kod Code	Ölçü Dimension	Kg
4395	60x60x115 mm	0.70

Kapı Emniyet Aparatı - *Gate Latch*



Kapı Emniyet Aparatı
Gate Latch

Kod Code	Ölçü Dimension	Kutu Adedi Pcs in a Box	Kg
8090	16x150 mm	12	0.65

Montaj Aksesuarları - *Fixing Elements*



8091
5 mm
30x100 mm



8092-A
5 mm
30x100 mm

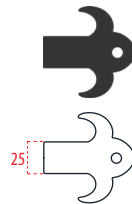

8093
3 mm
70x70 mm

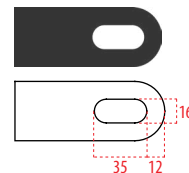

8094
8 mm
100x40 mm

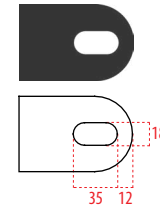

8095
8 mm
90x60 mm

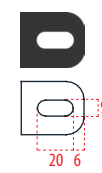

8096
4 mm
35x30 mm

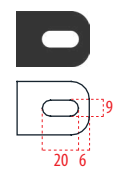

8097
4 mm
40x30 mm

Döküm Aksesuarlar - Cast Accessories



1060 mm

950 mm

6001

950x1060 mm
pik : 96 kg
alu : 33 kg



600 mm

1340 mm

6000

1340x600 mm
aluminium cast
18,10 kg

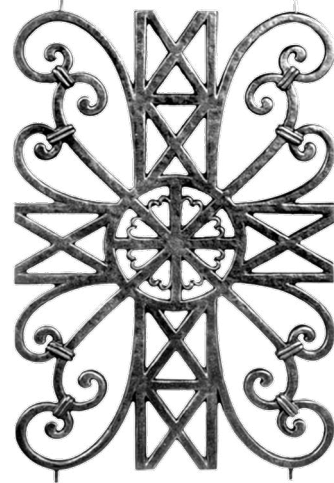

780 mm

530 mm

6002

530x780 mm
pik : 23,50 kg
alu : 8,75 kg

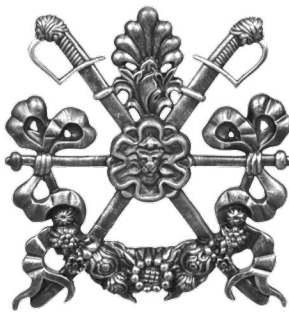

450 mm

6003

390x450 mm
pik : 10,10 kg
alu : 0,40 kg

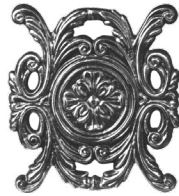

250 mm

6004

230x250 mm
pik : 2,10 kg
alu : 0,80 kg



640 mm

300 mm

6005

300x640 mm
pik : 18,30 kg
alu : 6,60 kg



6013

200x220 mm
5,38 kg

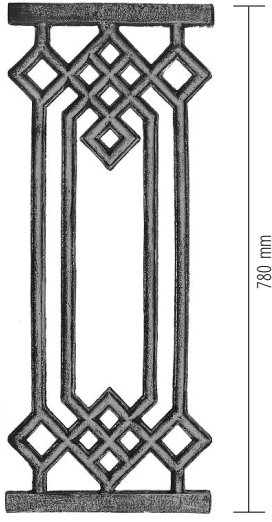

780 mm

320 mm

6006

320x780 mm
pik : 12,90 kg
alu : 4,70 kg



830 mm

320 mm

6007

320x830 mm
pik : 12,05 kg
alu : 4,50 kg

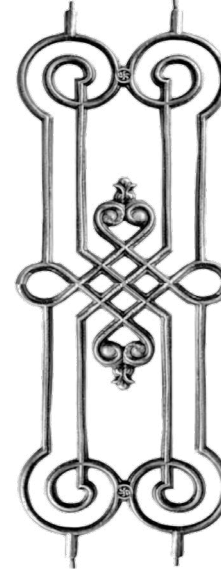

830 mm

320 mm

6008

320x830 mm
pik : 7,30 kg
alu : 2,70 kg



730 mm

150 mm

6009

150x730 mm
pik : 5,20 kg
alu : 1,93 kg



770 mm

180 mm

6010

180x770 mm
pik : 4,80 kg
alu : 1,78 kg



930 mm

240 mm

6011

240x930 mm
pik : 13,50 kg
alu : 5,00 kg



1050 mm

200 mm

6012

200x1050 mm
pik : 7,95 kg
alu : 2,95 kg

Banklar and Bank Ayakları- Benches and Bench Legs



Kod Code	Uzunluk Length	Genişlik Width	Yükseklik Height
7000	1450 mm	440 mm	420 mm



Kod Code	Alt Genişlik Lower Width	Üst Genişlik Upper Width	Yükseklik Height
7001	470 mm	440 mm	380 mm



Kod Code	Uzunluk Length	Genişlik Width	Yükseklik Height
7004	1450 mm	340 mm	430 mm

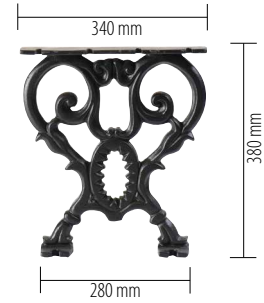

Kod Code	Alt Genişlik Lower Width	Üst Genişlik Upper Width	Yükseklik Height
7005	280 mm	340 mm	380 mm



Kod Code	Uzunluk Length	Genişlik Width	Yükseklik Height
7008	1450 mm	560 mm	750 mm



Kod Code	Genişlik Width	Ön Yükseklik Front Height	Arka Yükseklik Back Height
7009	560 mm	390 mm	750 mm



Kod Code	Uzunluk Length	Genişlik Width	Yükseklik Height
7012	1450 mm	580 mm	780 mm

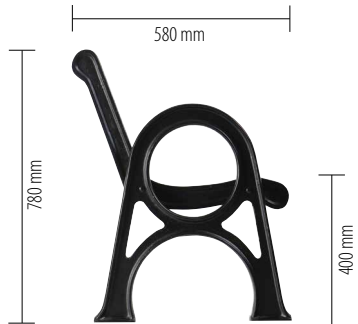

Kod Code	Genişlik Width	Ön Yükseklik Front Height	Arka Yükseklik Back Height
7013	580 mm	400 mm	780 mm

Çeşmeler - Fountains



7200
450x980 mm
d: 300 mm



7201
350x900 mm
d: 300 mm



7203
400x760 mm
d: 250 mm



7204
440x740 mm
d: 250 mm



7212
410x850 mm
d: 400 mm



7213
450x1240 mm
d: 540 mm

Musluklar - Faucets



7250



7251



7252

Posta Kutuları - Mail Boxes



7502
250x395 mm
d: 80 mm



7503
240x350 mm
d: 60 mm



7504
230x370 mm
d: 80 mm

Döküm Masalar ve Sandalyeler - Cast Tables and Chairs



Kod Code	Yükseklik Height	Tabla Ölçüsü Dimension
7304	730 mm	900x900 mm



Kod Code	Yükseklik Height	Tabla Ölçüsü Dimension
7305	730 mm	Ø 900 mm



Kod Code	Yükseklik Height	Genişlik Width	Derinlik Depth
7400	930 mm	440 mm	410 mm



Kod Code	Yükseklik Height	Genişlik Width	Derinlik Depth
7401	930 mm	440 mm	410 mm



Kod Code	Yükseklik Height	Genişlik Width	Derinlik Depth
7402	870 mm	440 mm	410 mm



Kod Code	Yükseklik Height	Genişlik Width	Derinlik Depth
7403	870 mm	440 mm	420 mm



Kod Code	Yükseklik Height	Genişlik Width	Derinlik Depth
7406	900 mm	570 mm	550 mm

Patina Boyalar ve Tinerler - Paints and Paint Thinners



4000

patina altın / patina gold
0.25 - 1.00 kg.



4001

patina bakır / patina copper
0.25 - 1.00 kg.



4002

patina bronz / patina bronze
0.25 - 1.00 kg.



4003

patina gümüş / patina silver
0.25 - 1.00 kg.



4004

patina pembe / patina pink
0.25 - 1.00 kg.



4005

patina yeşil / patina green
0.25 - 1.00 kg.



4006

siyah / black
1.00 - 5.00 - 18.00 kg.



4007

tiner / paint thinner
5.00 - 12.00 kg.

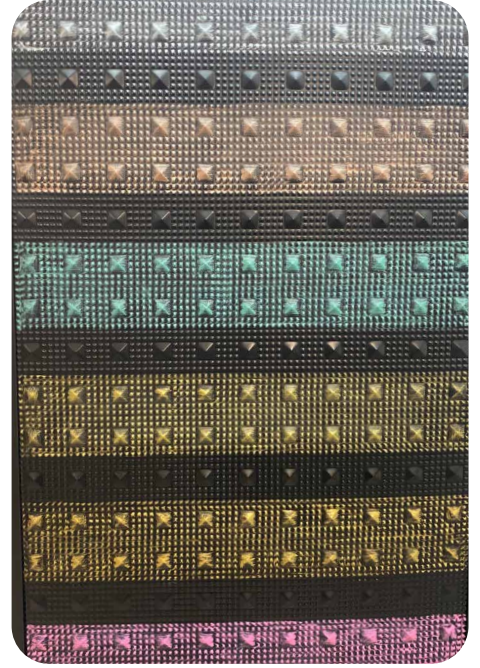

Harfler ve Rakamlar - Letters and Numbers

izli sac / patterned sheet

düz sac / plain sheet



4450-A 4451-A
h: 100 mm 3 mm h: 150 mm 3 mm



4450-B 4451-B
h: 100 mm 3 mm h: 150 mm 3 mm



4450-C 4451-C
h: 100 mm 3 mm h: 150 mm 3 mm



4455-A 4456-A
h: 100 mm 3 mm h: 150 mm 3 mm



4455-B 4456-B
h: 100 mm 3 mm h: 150 mm 3 mm



4455-C 4456-C
h: 100 mm 3 mm h: 150 mm 3 mm



4452-A
h: 50 mm 3 mm



4452-B
h: 100 mm 3 mm



4452-C
h: 50 mm 3 mm



4457-A
h: 50 mm 3 mm



4457-B
h: 100 mm 3 mm



4457-C
h: 50 mm 3 mm



4453-0 4454-0
h: 100 mm 3 mm h: 150 mm 3 mm



4453-1 4454-1
h: 100 mm 3 mm h: 150 mm 3 mm



4453-2 4454-2
h: 100 mm 3 mm h: 150 mm 3 mm



4458-0 4459-0
h: 100 mm 3 mm h: 150 mm 3 mm



4458-1 4459-1
h: 100 mm 3 mm h: 150 mm 3 mm



4458-2 4459-2
h: 100 mm 3 mm h: 150 mm 3 mm

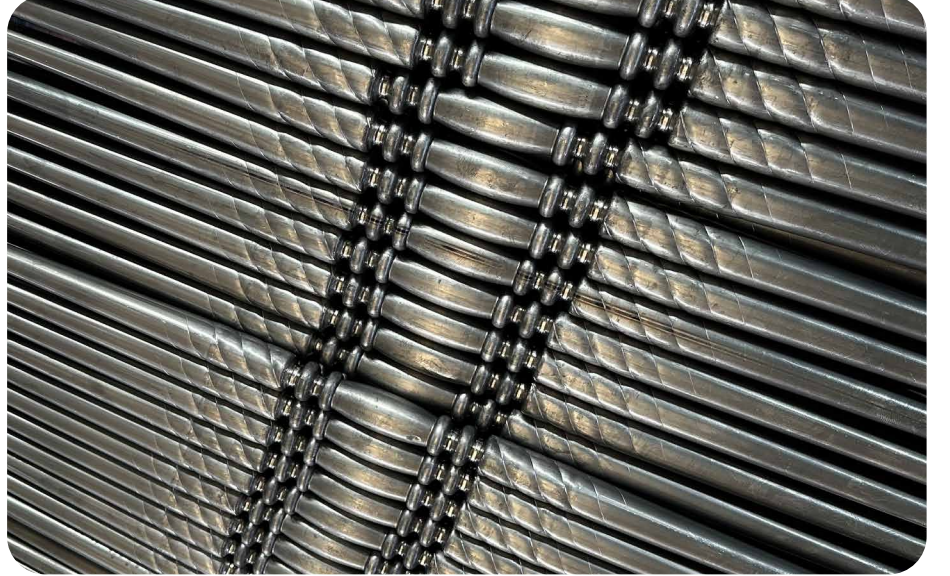
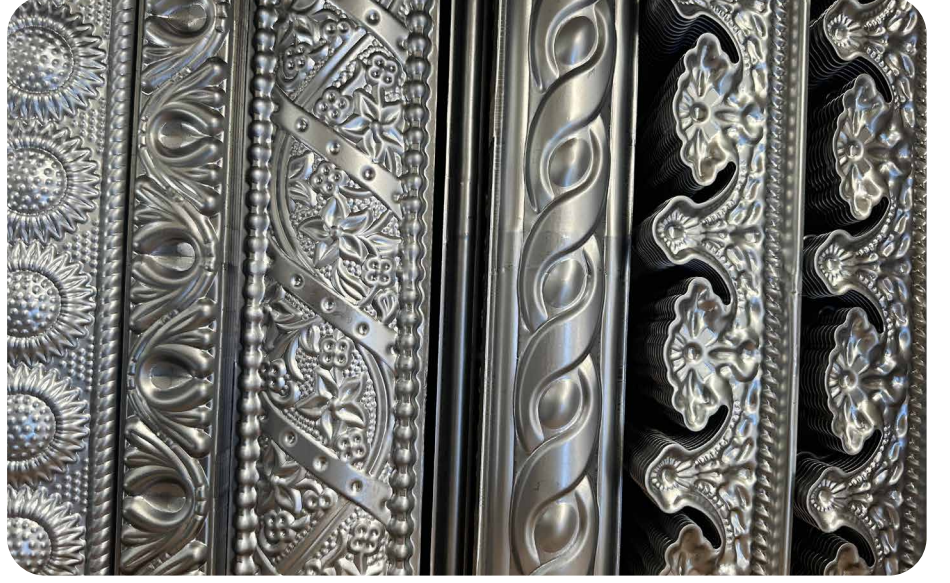





Diğer kataloglarımızı incelemek için lütfen QR kodu telefon kamerasına okutunuz.

Please scan the QR code with your phone camera to search our other catalogues.



KIRIMCI
METAL

KIRIMCI METAL FORM
SAN. ve TİC. AŞ.

Hasanağa Organize Sanayi Bölgesi
8. Cadde No.1 Nilüfer / Bursa / TURKEY

t. +90 224 482 26 02
t. +90 224 482 26 07

+90 531 624 65 88 (Export)
+90 534 088 74 98 (Yurtiçi Satış)

info@kirimcimetal.com
www.kirimcimetal.com