

KFENCE

FENCE SYSTEMS

by **KIRIMCI**
METAL



2026 korkuluk sistemleri katalođu

fence systems catalogue



dayanıklılık
durability



kaynak gerektirmez
no welding



tasarım
design



gizlilik ve güvenlik
privacy and security



renk seçenekleri
color options



boyut çeşitliliđi
variety of dimensions



kolay kurulum
easily assembly



rüzgar dayanımı
wind resistant



yüksek kalite
high quality

Hakkımızda

About Us



K-FENCE korkuluk sistemleri; KIRIMCI METAL FORM SAN. TİC A.Ş. çatısı altında Bursa'daki fabrikamızda üretilmektedir. Korkuluk sistemlerimiz; ihtiyaca göre; konut, ticari yapılar, endüstriyel tesisler ve kamu alanlarında kullanılmaktadır. Yüksek kaliteli, dayanıklı ve uzun ömürlü korkuluk çözümleri ile müşterilerimize hizmet vermekteyiz.

10,000 m²'lik fabrikamızda; Avrupa standartlarında üretim kalitemiz ve "Yüksek kalite-Hızlı sevkiyat-İyi hizmet" anlayışımız ile, galvanizli çelik, siyah sac ve ferforje gibi dayanıklı malzemelerle, projeye özel farklı alternatifler sunuyor; müşterilerimizin ihtiyaç ve beklentilerini en üst düzeyde karşılıyoruz. Tüm süreçlerde kalite standartlarımızdan ödün vermeden, hem görselliği hem de güvenliği ön planda tutuyoruz.



K-FENCE fence systems; are manufactured in our factory in Bursa under the roof of KIRIMCI METAL FORM SAN. TİC A.Ş. Our fence systems; are used in housing, commercial buildings, industrial facilities and public areas according to the need. We serve our customers with high quality, durable and long-lasting railing solutions.

In our 10,000 m² factory; with our production quality at European standards and our understanding of "High quality-Fast shipment-Good service", we offer different project-specific alternatives with durable materials such as galvanized steel, black sheet and wrought iron; we meet the needs and expectations of our customers at the highest level. We prioritize both visibility and safety without compromising our quality standards in all processes.

K-FENCE sisteminin özellikleri nelerdir?

What are the features of the K-FENCE system?



K-FENCE korkuluk sistemleri; tüm ürün bileşenleri Avrupa standartlarında ve galvanizli metal malzemeden üretilmesi sebebiyle oldukça dayanıklı ve uzun ömürlüdür.

K-FENCE korkuluk sistemleri; kolay montaj detayları sayesinde, kaynak gerektirmeden ve ilave maliyete gerek kalmadan kolayca montaj yapılabilir.

K-FENCE korkuluk sistemleri; farklı boyut ve renk seçenekleriyle tüm gereksinimlere cevap vermekle birlikte, çevreye ve projenize kolaylıkla uyum sağlar.

K-FENCE fence systems; all product components are manufactured in accordance with European standards and from galvanized metal material, so they are quite durable and long-lasting.

K-FENCE fence systems; with easy assembly details, can be easily assembled without the need for welding and additional costs.

K-FENCE fence systems; meet all requirements with different size and color options, and easily adapt to the environment and your project.



dayanıklılık *durability*

galvanizli metal hava şartlarına dayanıklı olduğundan paslanma yapmaz, bu sayede uzun yıllar çit bakımı konusunda endişelenmenize gerek kalmaz

galvanized metal is resistant to weather conditions and does not corrode, so you do not have to worry about the maintenance of the fence for many years



kaynak gerektirmez *no welding*

sistemin tüm bileşenleri özel olarak birleştirilmiştir, bu nedenle kaynak gerektirmez

all the elements of the fence are joined by special mounting details, so there is no need for welding



tasarım *design*

modern formuyla tüm mimari tarzlara kolaylıkla uyum sağlar

it can easily adapt to the all architectural styles with its modern style



gizlilik ve güvenlik *privacy and security*

açık alanda mahremiyet ve güvenlik hissi sağlayan bir alan oluşturur

it provides a sense of privacy and security



renk seçenekleri *color options*

istenilen renkte elektrostatik toz boya yapılabilir

electrostatic powder coating can be done in any desired color



boyut çeşitliliği *variety of dimensions*

gereksinimlerinize göre farklı ölçü alternatifleri sunar

many size options depending on your requirements



kolay kurulum *easily assembly*

özel montaj detayı sayesinde kolay ve hızlı kurulum sağlar

provides easy and fast installation due to its special assembly detail



rüzgar dayanımı *wind resistant*

sağlam yapısı sebebiyle rüzgara karşı dayanıklıdır

strong structure makes it resistant to wind



yüksek kalite *high quality*

yüksek kapasite ve teknolojik imkanlarla üretilen AR-GE ürünüdür

R&D product produced with high capacity and technological facilities

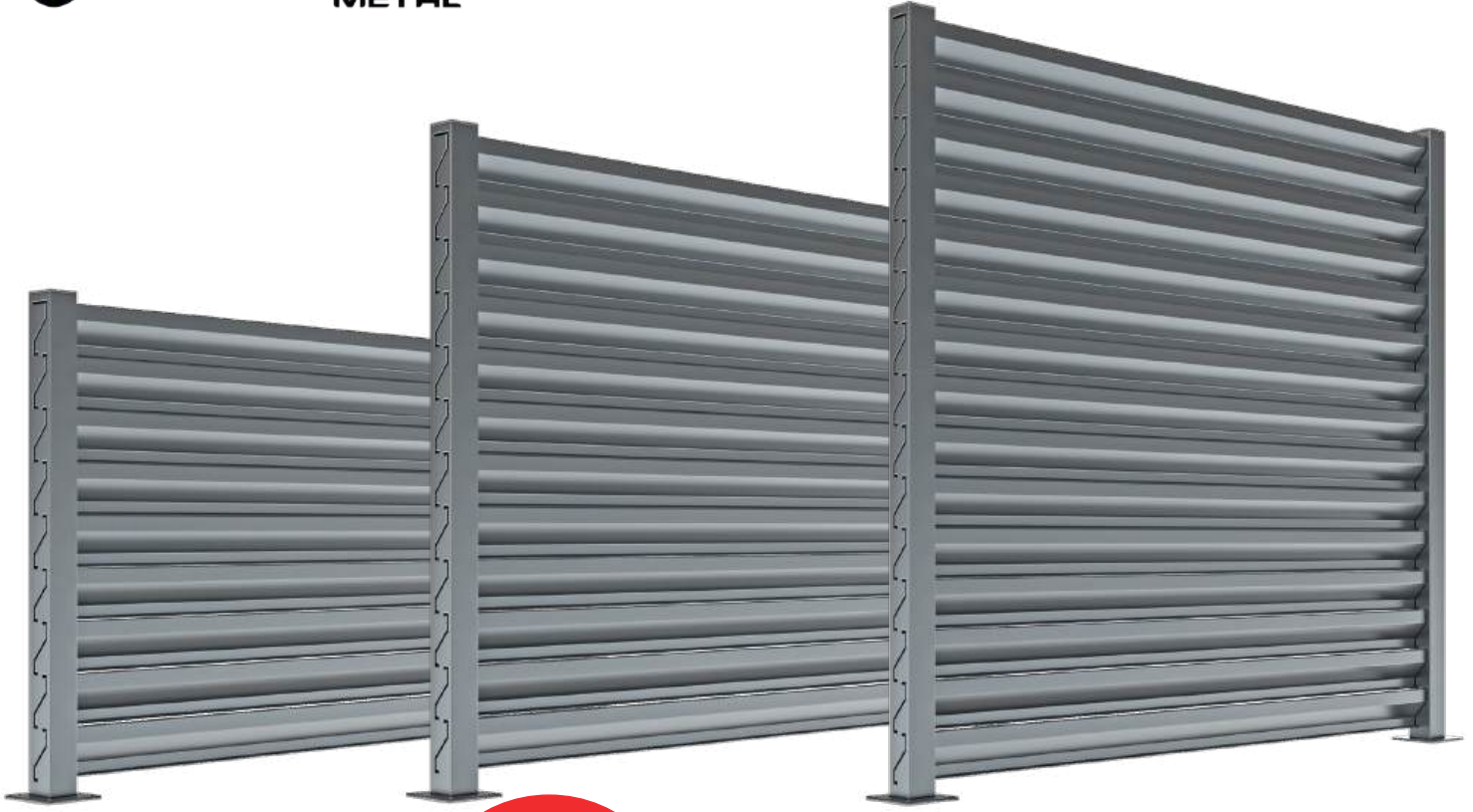

NEMRUT

panjur çit
shutter fence

Panjur Çit Sistemleri, modern yapılarda güvenliği estetikle birleştiren yenilikçi çit çözümleri sunar. Gelişen üretim teknolojileriyle tasarlanan bu sistemler, dayanıklı yapısı, uzun ömürlü malzemeleri ve zarif görünümüyle hem konut hem de endüstriyel alanlarda tercih edilmektedir.

Panjur çit sistemleri, yatay metal lamellerden oluşur. Bu yapı, hem dışarıdan görüşü sınırlandırarak mahremiyet sağlar hem de dış etkenlere karşı yüksek koruma sunar.

Shutter fence systems offer innovative fence solutions that combine security with aesthetics in modern buildings. Designed with advanced manufacturing technologies, these systems are preferred in both residential and industrial areas due to their durable structure, long-lasting materials, and elegant appearance.

Shutter fence systems consist of horizontal metal slats. This structure provides privacy by limiting visibility from the outside, while also offering high protection against external elements.

PROFİL

galvanizli profil
flanş kaynaklı

POST

galvanized profile
welded flange



demonte sistem
diy system

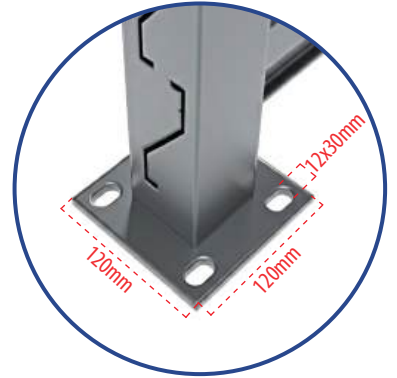

zemine kolay montaj
easy installation to ground

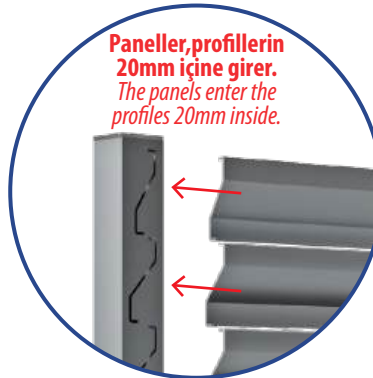

**Paneller, profillerin
20mm içine girer.**
The panels enter the
profiles 20mm inside.

kolay montaj
easy installation

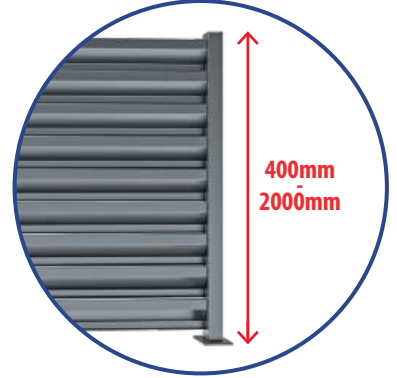

yükseklik çeşitliliği
variety of height

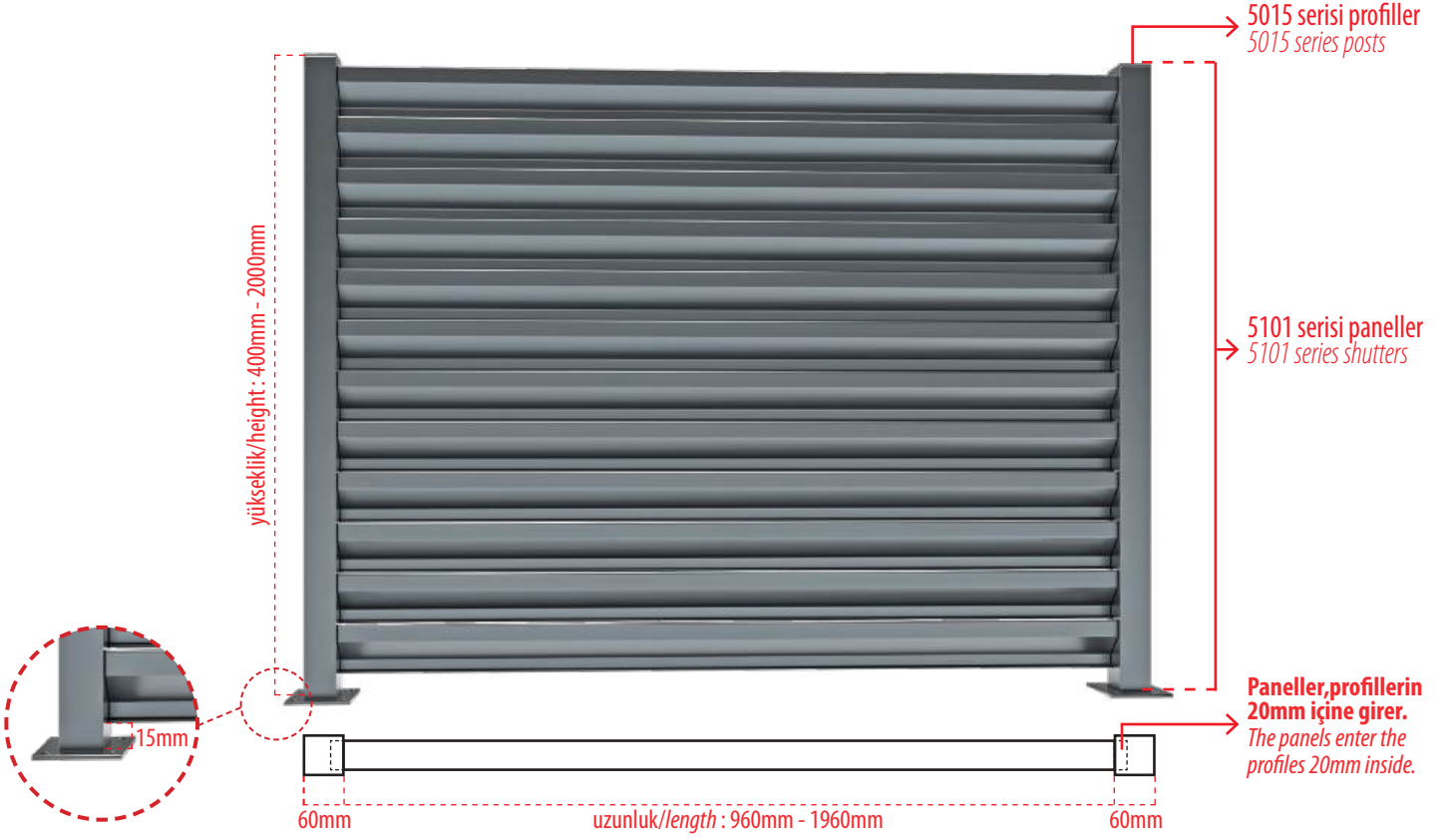

Profil Post			
Görsel Image	Kod Code	Yükseklik Height	Kullanılacak Panel Sayısı Pieces of Panel
	5015-400	400 mm	4
	5015-500	500 mm	5
	5015-600	600 mm	6
	5015-750	750 mm	8
	5015-850	850 mm	9
	5015-940	940 mm	10
	5015-1000	1000 mm	11
	5015-1200	1200 mm	13
	5015-1480	1480 mm	16
	5015-1750	1750 mm	19
	5015-2000	2000 mm	22

***Standart profiller; 1.5mm kalınlıktaki 60x60mm GALVANİZLİ profilden üretilmektedir.
*** Standard profiles are produced from 60x60mm GALVANIZED profile with 1.5 mm thickness.

***Her profil; kendinden kaynaklı 120x120x4mm flanşıyla ve 60x60mm plastik kapağıyla birlikte takım halinde.
***Each post is supplied as a set with its own welded 120x120x4mm flange and 60x60mm plastic lid.

Panel Shutter		
Görsel Image	Kod Code	Uzunluk Length
	5101-1000	1000 mm
	5101-1200	1200 mm
	5101-1500	1500 mm
	5101-2000	2000 mm

***Paneller; 1mm kalınlıktaki galvanizli sacdan üretilmektedir.
***Shutters are produced from 1mm thickness galvanized sheet metal.

***Paneller, profillerin 20mm içine girer.
***The shutters enter the profiles 20mm inside.

***Paneller ve profiller isteğe bağlı olarak, boyalı veya boyasız olarak üretilmektedir.
***Shutters and posts is produced in painted or unpainted versions, upon request.

***Uygulama Örneği: 100cm yüksekliğindeki Nemrut model uygulaması için;
5015-1000 kodlu profil + 11 adet 5101 serisi panjur panel kullanılmaktadır.
Panjur panellerinde 100cm,120cm, 150cm ve 200cm uzunluk alternatifleri bulunmaktadır.
***Application Example: 100cm height Nemrut model application;
Profile code 5015-1000 + 11 pieces of 5101 series shutter panels are used.
Shutter panels are available in 100cm, 120cm, 150cm and 200cm length alternatives.

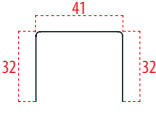
Panjur Kapı Sabitleme U Kanal Profili Shutter Door Fitting U Profile			
Görsel Image	Kod Code	Ölçü Dimension	Uzunluk Length
	5005-1500		1500 mm
	5005-2000		2000 mm
	5005-2500	32x41x32 mm	2500 mm

***Panjur kapıların çerçeve ve sabitleme noktalarında kullanılan U Kanal Profili, kapının düzgün çalışmasını ve sağlam bir şekilde monte edilmesini sağlar.
***Shutter Door Fitting U Profile used in the frame and fixing points of roller shutter doors ensures the door operates smoothly and is securely mounted.

***U kanal profil, kapı kasasına vida ile sabitlendikten sonra, panjur paneller vida ile U kanala monte edilir.
***After the U Shaped Profile is fixed to the door frame with screws, the shutter panels are mounted to the U Shaped Profile with screws.

***U Kanal Profilleri; 1.5mm kalınlıktaki galvanizli sacdan, boyalı veya boyasız olarak üretilmektedir.
***U Shaped Profiles are produced from 1.5mm galvanized sheet metal, either painted or unpainted.

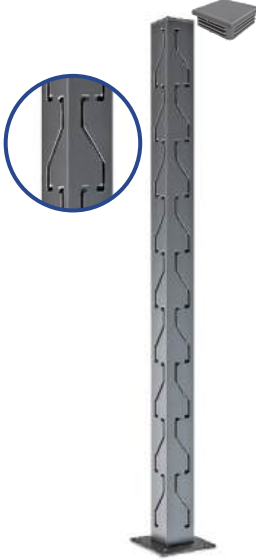
Nemrut Köşe Profil Nemrut Corner Profile			
Görsel Image	Kod Code	Yükseklik Height	Kullanılacak Panel Sayısı Pieces of Panel
	5009-400	400 mm	4
	5009-500	500 mm	5
	5009-600	600 mm	6
	5009-750	750 mm	8
	5009-850	850 mm	9
	5009-940	940 mm	10
	5009-1000	1000 mm	11
	5009-1200	1200 mm	13
	5009-1480	1480 mm	16
	5009-1750	1750 mm	19
	5009-2000	2000 mm	22

***Köşe Profiller, panjur çit projelerinizdeki köşe noktaları için tasarlanmış olup; boyalı veya boyasız olarak üretilmektedir. İstenildiği takdirde diğer modellerimiz için de köşe profil üretimi yapılabilir.
*** Corner profiles are designed for corner points in your shutter fence projects and are produced in painted or unpainted according to your needs. Corner profiles can also be produced for our other models if requested.

***Köşe profilleri; 1.5mm kalınlıktaki 60x60mm GALVANİZLİ profilden üretilmektedir.
*** Corner profiles are produced from 60x60mm GALVANIZED profile with 1.5 mm thickness.

***Köşe profiller, kendinden kaynaklı 120x120x4mm flanşıyla ve 60x60mm plastik kapağıyla birlikte takım halinde.
***Each corner post is supplied as a set with its own welded 120x120x4mm flange and 60x60mm plastic lid.

Kapı Profili Door Profile			
Görsel Image	Kod Code	Yükseklik Height	Kullanılacak Panel Sayısı Pieces of Panel
	5006-1500	1500 mm	15
	5006-2000	2000 mm	21
	5006-2500	2500 mm	26

***Kapı Profilleri, yaya giriş kapıları ve garaj kapıları için tasarlanmış olup, U kanallarla beraber kullanılmaktadır. İsteğe bağlı boyalı veya boyasız olarak üretilmektedir.
*** Door profiles are designed for pedestrian entrance doors and garage doors and are used with U-shaped channels. It can be produced in painted or unpainted versions.

***Kapı profilleri; 1.5mm kalınlıktaki 60x60mm GALVANİZLİ profilden flanşsız olarak üretilmektedir.
*** Door profiles are produced from 60x60mm GALVANIZED profile with 1.5 mm thickness without flange.



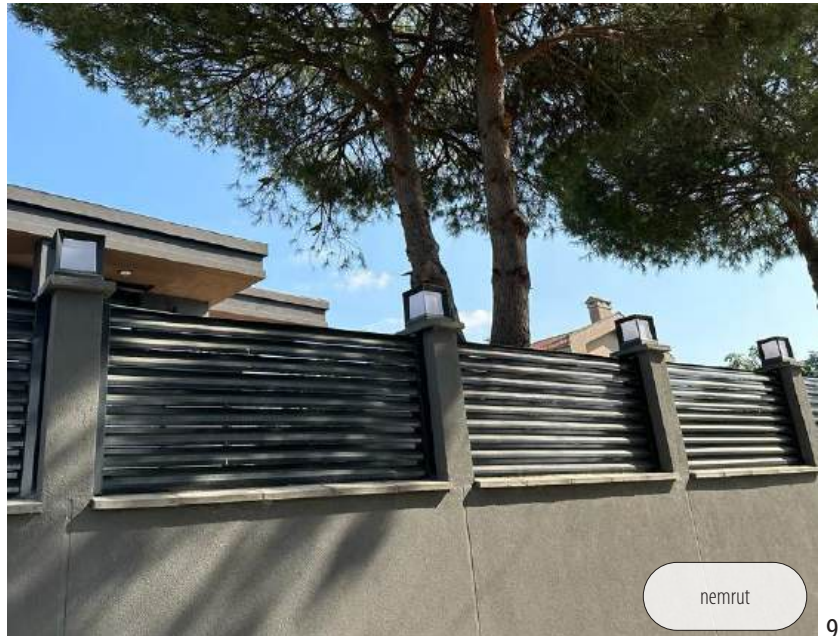



TOROS

lazer kesimli panjur çit
shutter fence with laser-cut

Panjur çit sistemine ek olarak panelin üst kısmına eklenecek yatay lazer kesimli panel ile farklı bir görsel yaratabilirsiniz. Lazer kesimli paneli; standart desenlerimizden seçebileceğiniz gibi, projenize uygun yazı ve deseni de tercih edebilirsiniz.

4 farklı yükseklik alternatifiyle; mahremiyet ihtiyacını karşıladığı gibi, şık tasarımıyla projelerinize uyum sağlar.

In addition to the shutter fence system, you can create a different design with a horizontal laser-cut panel added to the top of the panel. You can choose the laser-cut panel from our standard patterns, as well as the text and pattern that suits your project.

With 4 different height alternatives; it meets the need for privacy and adapts to your projects with its stylish design.

PROFİL

galvanizli profil
flanş kaynaklı

POST

galvanized profile
welded flange



demonte sistem
diy system

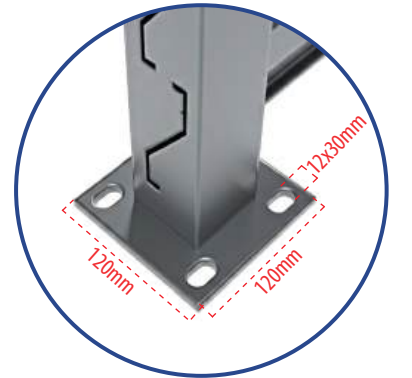

zemine kolay montaj
easy installation to ground

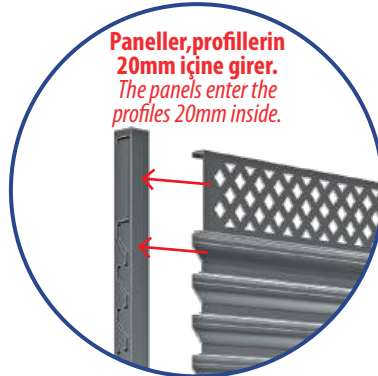

lazer kesimli panel-özel büküm detayı
laser-cut panel and special bending detail

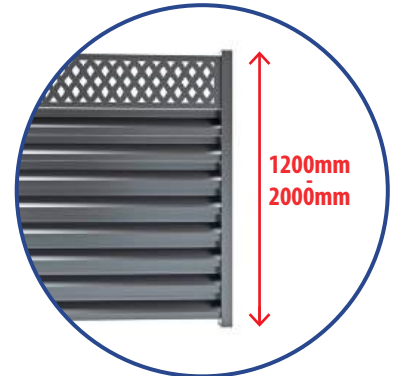

yükseklik çeşitliliği
variety of height

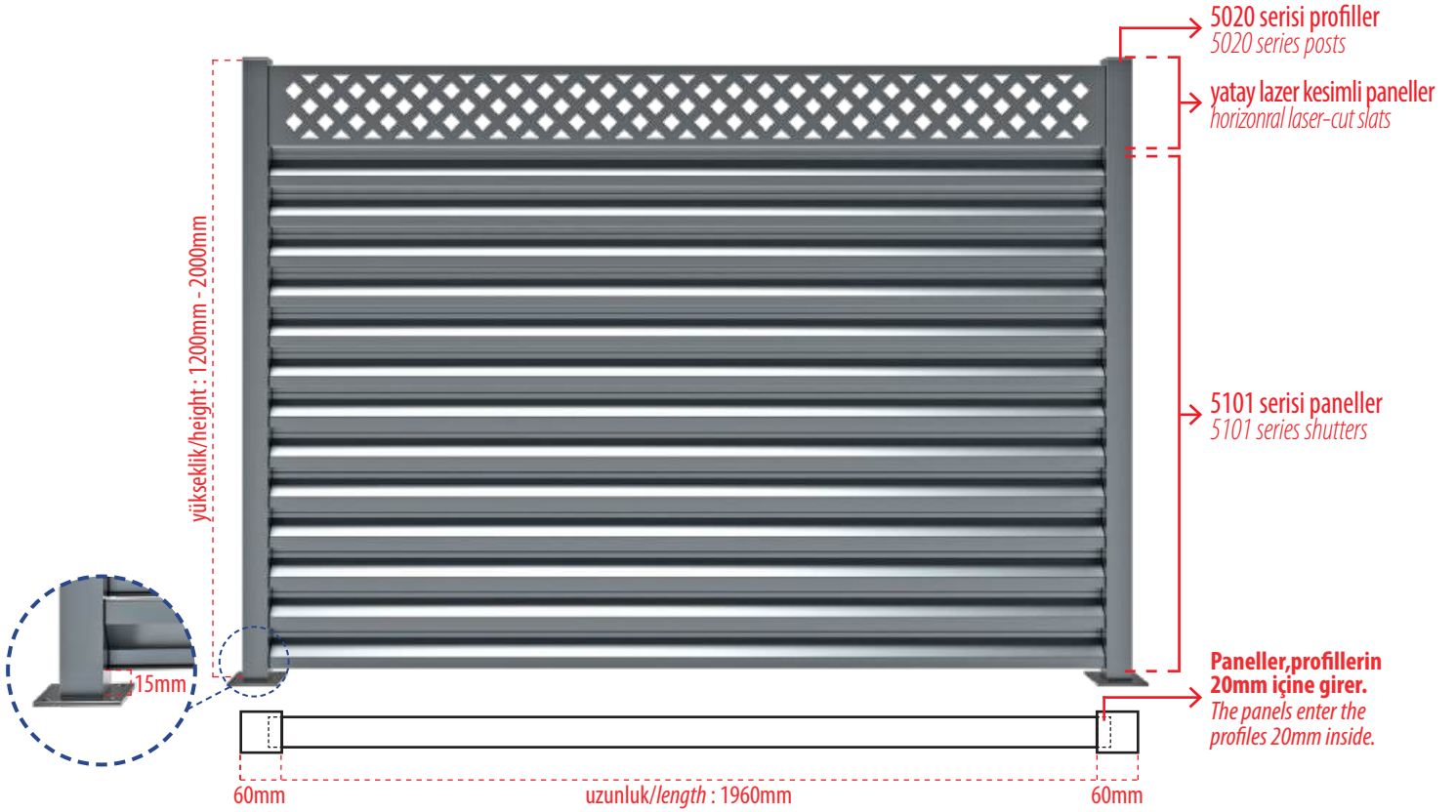

Profil Post			
Görsel Image	Kod Code	Yükseklik Height	Kullanılacak Panel Sayısı Pieces of Panel
	5020-1200	1200 mm	1+11
	5020-1480	1480 mm	1+14
	5020-1750	1750 mm	1+17
	5020-2000	2000 mm	1+20

***Standart profiller; 1.5mm kalınlıktaki 60x60mm GALVANİZLİ profilden üretilmektedir.
*** Standard profiles are produced from 60x60mm GALVANIZED profile with 1.5 mm thickness.

***Her profil; kendinden kaynaklı 120x120x4mm flanşıyla ve 60x60mm plastik kapağıyla birlikte takım halinde dir.
***Each post is supplied as a set with its own welded 120x120x4mm flange and 60x60mm plastic lid.

***Paneller ve profiller isteğe bağlı olarak, boyalı veya boyasız olarak üretilmektedir.
***Shutters and posts is produced in painted or unpainted versions, upon request.

Yatay Panel Horizontal Slat			
Görsel Image	Kod Code	Yükseklik Height	Uzunluk Length
	5110-2000	190 mm	2000 mm
	5111-2000	190 mm	2000 mm
	5112-2000	190 mm	2000 mm
***Yatay lazer kesimli paneller; 1.5mm kalınlıktaki galvanizli sacdan üretilmektedir. ***Horizontal laser-cut slats are produced from 1.5mm thickness galvanized sheet metal.			
	5101-2000	90 mm	2000 mm
***5101 serisi paneller; 1mm kalınlıktaki galvanizli sacdan üretilmektedir. ***5101 series slats are produced from 1mm thickness galvanized sheet metal.			
***Uygulama Örneği: 120cm yüksekliğindeki Toros model uygulaması için; 5020-1200 kodlu profil + 1 adet yatay lazer kesimli panel + 11 adet 5101-2000 kodlu panjur panel kullanılmaktadır. Bu modelde lazer kesimli panellerin ve panjur panellerinin uzunluğu standart olarak 200cm'dir. ***Application Example: 120cm height Toros model application; Profile code 5020-1200 + 1 horizontal laser-cut panel + 11 shutter panels from the 5101-2000 code are used. In this model, the length of the panels are 200cm as standard.			

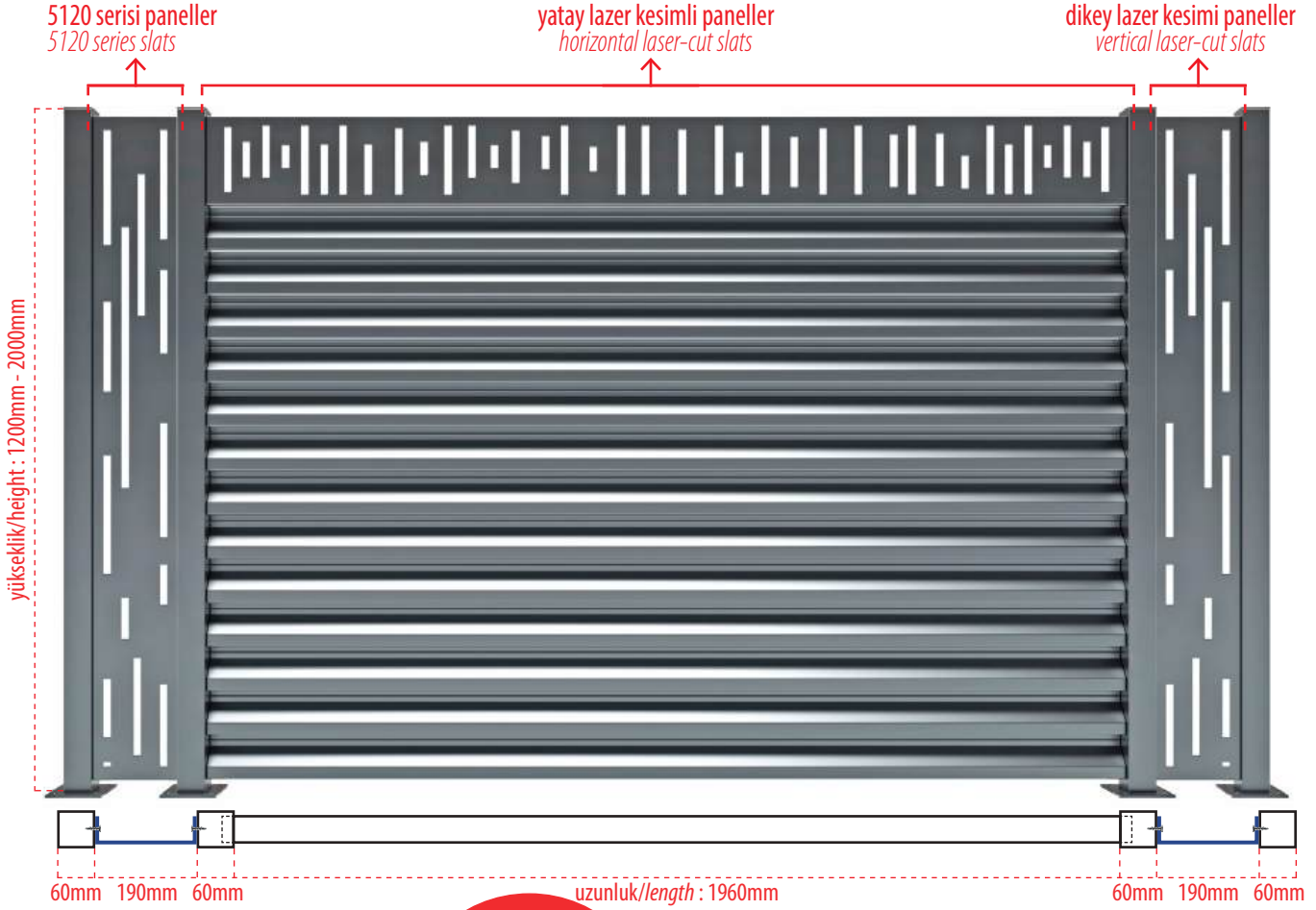

ERCİYES

lazer kesimli panjur çit

shutter fence with laser-cut

Panjur çit sistemine ek olarak panelin üst ve yan kısmına eklenecek yatay ve dikey lazer kesimli paneller ile farklı bir görsel yaratabilirsiniz. Lazer kesimli panelleri; standart desenlerimizden seçebileceğiniz gibi, projenize uygun yazı ve deseni de tercih edebilirsiniz.

4 farklı yükseklik alternatifiyle; mahremiyet ihtiyacını karşıladığı gibi, şık tasarımıyla projelerinize uyum sağlar.

In addition to the shutter fence system, you can create a different visual effect by adding horizontal and vertical laser-cut panels to the top and sides of the panel. You can choose laser-cut panels from our standard designs, or you can opt for text and designs suitable for your project.

With 4 different height alternatives; it meets the need for privacy and adapts to your projects with its stylish design.

PROFİL

galvanizli profil
flanş kaynaklı

POST

galvanized profile
welded flange



demonte sistem
diy system

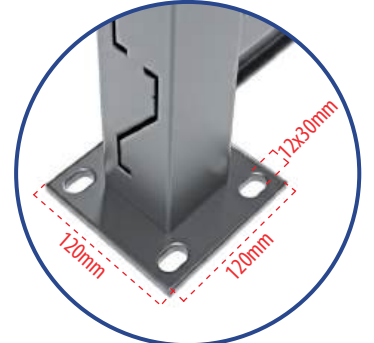

zemine kolay montaj
easy installation to ground

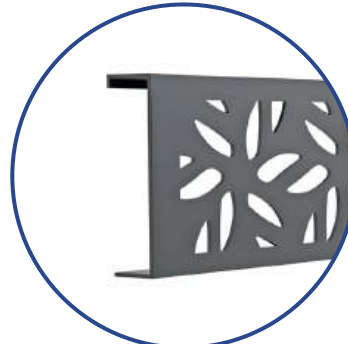

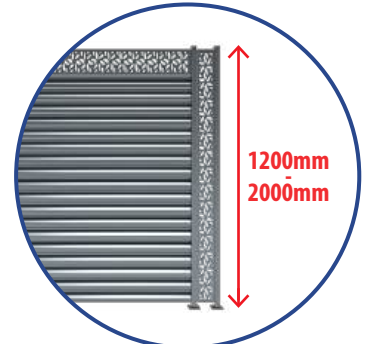

lazer kesimli panel-özel büküm detayı
laser-cut panel and special bending detail



yükseklik çeşitliliği
variety of height

Profil Post			
Görsel Image	Kod Code	Yükseklik Height	Kullanılacak Panel Sayısı Pieces of Panel
	5025-1200	1200 mm	1+11+1
	5025-1480	1480 mm	1+14+1
	5025-1750	1750 mm	1+17+1
	5025-2000	2000 mm	1+20+1
<p>***Standart profiller; 1.5mm kalınlıktaki 60x60mm GALVANİZLİ profilden üretilmektedir. *** Standard profiles are produced from 60x60mm GALVANIZED profile with 1.5 mm thickness.</p> <p>***Her profil; kendinden kaynaklı 120x120x4mm flanşıyla ve 60x60mm plastik kapağıyla birlikte takım halinde.</p> <p>***Each post is supplied as a set with its own welded 120x120x4mm flange and 60x60mm plastic lid.</p> <p>***Paneller ve profiller isteğe bağlı olarak, boyalı veya boyasız olarak üretilmektedir. ***Shutters and posts is produced in painted or unpainted versions, upon request.</p> <p>***Uygulama Örneği: 120cm yüksekliğindeki Erciyes model uygulaması için; 5025-1200 kodlu profil + 1 adet yatay lazer kesimli panel + 11 adet 5101-2000 kodlu panjur panel + 1 adet dikey lazer kesimli panel kullanılmaktadır. Bu modelde yatay lazer kesimli panellerin ve panjur panellerinin uzunluğu standart olarak 200cm'dir.</p> <p>***Application Example: 120cm height Erciyes model application; Profile code 5025-1200 + 1 horizontal laser-cut panel + 11 shutter panels from the 5101-2000 code + 1 vertical laser-cut panel are used. In this model, the length of the horizontal panels are 200cm as standard.</p>			

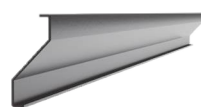
Yatay Panel Horizontal Slat			
Görsel Image	Kod Code	Yükseklik Height	Uzunluk Length
	5110-2000	190 mm	2000 mm
	5111-2000	190 mm	2000 mm
	5112-2000	190 mm	2000 mm
<p>***Yatay lazer kesimli paneller; 1.5mm kalınlıktaki galvanizli sacdan üretilmektedir. ***Horizontal laser-cut slats are produced from 1.5mm thickness galvanized sheet metal.</p>			
	5101-2000	90 mm	2000 mm
<p>***5101 serisi paneller; 1mm kalınlıktaki galvanizli sacdan üretilmektedir. ***5101 series slats are produced from 1mm thickness galvanized sheet metal.</p>			

Dikey Lazer Kesimli Panel Vertical Laser-Cut Slat			
Görsel Image	Kod Code	Genişlik Width	Yükseklik Height
	5120-1170	190 mm	1170 mm
	5120-1450		1450 mm
	5120-1720		1720 mm
	5120-1970		1970 mm
	5121-1170	190 mm	1170 mm
	5121-1450		1450 mm
	5121-1720		1720 mm
	5121-1970		1970 mm
	5122-1170	190 mm	1170 mm
	5122-1450		1450 mm
	5122-1720		1720 mm
	5122-1970		1970 mm
<p>***Dikey lazer kesimli paneller; 1.5mm kalınlıktaki galvanizli sacdan üretilmektedir. ***Vertical laser-cut slats are produced from 1.5mm thickness galvanized sheet metal.</p>			



PROFİL

galvanizli profil
flanş kaynaklı

POST

galvanized profile
welded flange

İLGAZ
yatay lamelli modern çit
horizontal slat modern fence

Yatay lamelli modern çitler, U formunda bükülmüş galvanizli sacların kompozisyonu ile oluşturulmuştur. Hem modern bir görüntü hem de yüksek mahremiyet sağlar.

İlgaz modelinde yatay lameller 9cm genişliğindedir.

Modern horizontal slat fences are constructed from a composition of U-shaped bent galvanized sheet metal. They provide both a modern look and high privacy.

In the İlgaz model, the horizontal slats are 9cm wide.

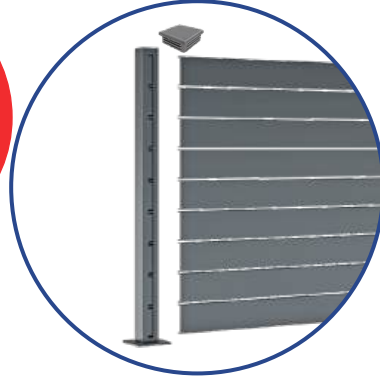

demonte sistem
diy system

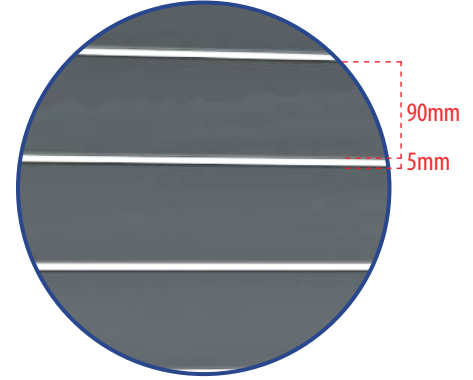

maksimum gizlilik-5mm boşluk
maximum privacy-5mm gap

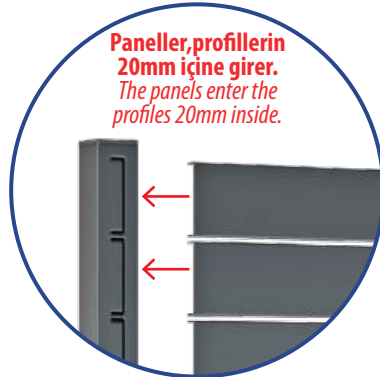

kolay montaj
easy installation

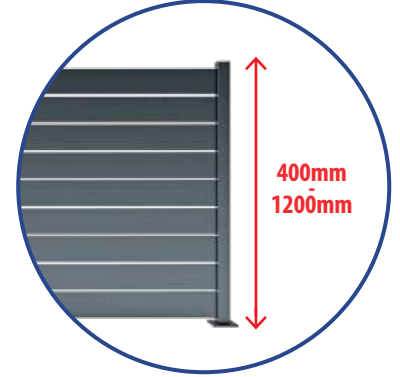

yükseklik çeşitliliği
variety of height

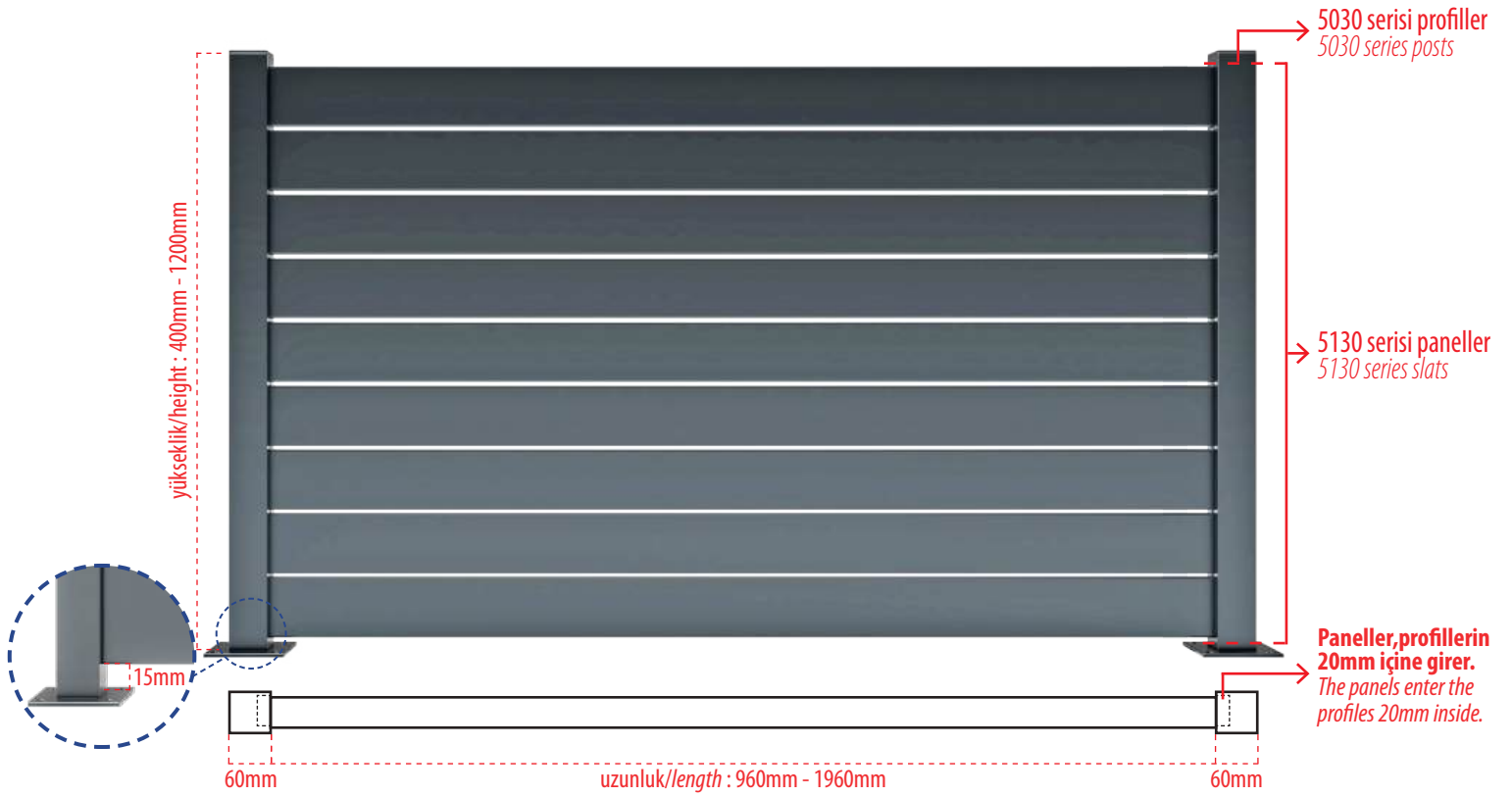

Profil Post			
Görsel Image	Kod Code	Yükseklik Height	Kullanılacak Panel Sayısı Pieces of Panel
	5030-400	400 mm	4
	5030-500	500 mm	5
	5030-600	600 mm	6
	5030-700	700 mm	7
	5030-800	800 mm	8
	5030-900	900 mm	9
	5030-1000	1000 mm	10
	5030-1200	1200 mm	12

***Standart profiller; 1.5mm kalınlıktaki 60x60mm GALVANİZLİ profilden üretilmektedir.
 *** Standard profiles are produced from 60x60mm GALVANIZED profile with 1.5 mm thickness.

***Her profil; kendinden kaynaklı 120x120x4mm flanşıyla ve 60x60mm plastik kapağıyla birlikte takım halindedir.
 ***Each post is supplied as a set with its own welded 120x120x4mm flange and 60x60mm plastic lid.

Yatay Lamel Horizontal Slat			
Görsel Image	Kod Code	Genişlik Width	Uzunluk Length
	5130-1000	90 mm	1000 mm
	5130-1200	90 mm	1200 mm
	5130-1500	90 mm	1500 mm
	5130-2000	90 mm	2000 mm

***Paneller; 1mm kalınlıktaki galvanizli sacdan üretilmektedir.
 ***Slats are produced from 1mm thickness galvanized sheet metal.

***Paneller ve profiller isteğe bağlı olarak, boyalı veya boyasız olarak üretilmektedir.
 ***Shutters and posts is produced in painted or unpainted versions, upon request.

***Uygulama Örneği: 120cm yüksekliğindeki Ilgaz model uygulaması için; 5030-1200 kodlu profil + 12 adet 5130 serisi yatay lamel kullanılmaktadır. Yatay lamellerde 100cm, 120cm, 150cm ve 200cm uzunluk alternatifleri bulunmaktadır.
 ***Application Example: 120cm height Ilgaz model application; Profile code 5030-1200 + 12 horizontal panel from the 5130 series are used. In this model, horizontal slats are available in lengths of 100cm, 120cm, 150cm, and 200cm.



AYDOS

yatay lamelli modern çit
horizontal slat modern fence

Yatay lamelli modern çitler, U formunda bükülmüş galvanizli sacların kompozisyonu ile oluşturulmuştur. Hem modern bir görüntü hem de yüksek mahremiyet sağlar.

Aydos modelinde yatay lameller 18cm genişliğindedir.

Modern horizontal slat fences are constructed from a composition of U-shaped bent galvanized sheet metal. They provide both a modern look and high privacy.

In the Aydos model, the horizontal slats are 18cm wide.

PROFİL

galvanizli profil
flanş kaynaklı

POST

galvanized profile
welded flange

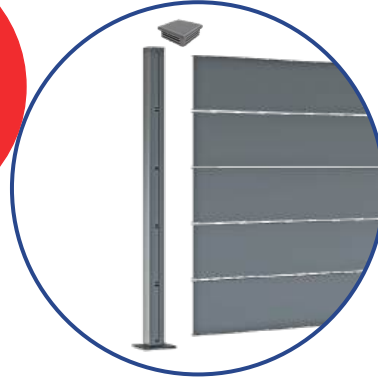

demonte sistem
diy system

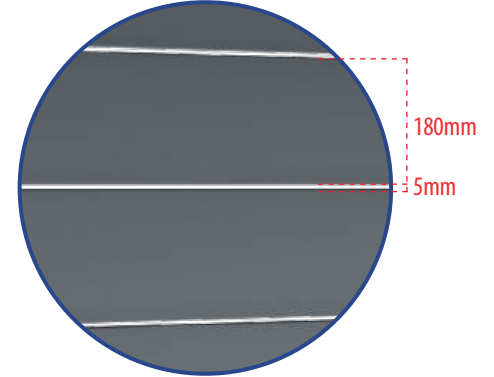

maksimum gizlilik-5mm boşluk
maximum privacy-5mm gap

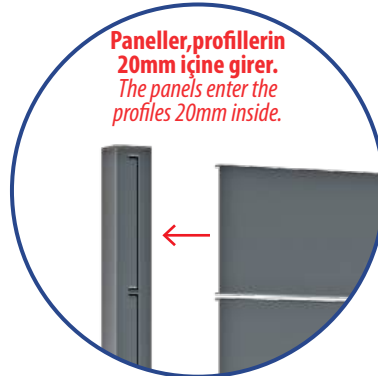

**Paneller,profillerin
20mm içine girer.**
The panels enter the
profiles 20mm inside.

kolay montaj
easy installation

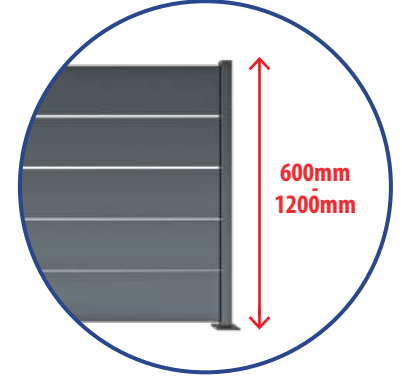

yükseklik çeşitliliği
variety of height



Profil Post			
Görsel Image	Kod Code	Yükseklik Height	Kullanılacak Panel Sayısı Pieces of Panel
	5035-600	600 mm	3
	5035-800	800 mm	4
	5035-1000	1000 mm	5
	5035-1200	1200 mm	6
	***Standart profiller; 1.5mm kalınlıktaki 60x60mm GALVANİZLİ profilden üretilmektedir. *** Standard profiles are produced from 60x60mm GALVANIZED profile with 1.5 mm thickness.		
***Her profil; kendinden kaynaklı 120x120x4mm flanşıyla ve 60x60mm plastik kapağıyla birlikte takım halinde. ***Each post is supplied as a set with its own welded 120x120x4mm flange and 60x60mm plastic lid.			

Yatay Lamel Horizontal Slat			
Görsel Image	Kod Code	Genişlik Width	Uzunluk Length
	5140-1000	180 mm	1000 mm
	5140-1200	180 mm	1200 mm
	5140-1500	180 mm	1500 mm
	5140-2000	180 mm	2000 mm
***Paneller; 1mm kalınlıktaki galvanizli sacdan üretilmektedir. ***Slats are produced from 1mm thickness galvanized sheet metal.			
***Paneller ve profiller isteğe bağlı olarak, boyalı veya boyasız olarak üretilmektedir. ***Shutters and posts is produced in painted or unpainted versions, upon request.			
***Uygulama Örneği: 120cm yüksekliğindeki Aydos model uygulaması için; 5035-1200 kodlu profil + 6 adet 5140 serisi yatay lamel kullanılmaktadır. Yatay lamellerde 100cm, 120cm, 150cm ve 200cm uzunluk alternatifleri bulunmaktadır. ***Application Example: 120cm height Aydos model application; Profile code 5035-1200 + 6 horizontal panel from the 5140 series are used. In this model, horizontal slats are available in lengths of 100cm, 120cm, 150cm, and 200cm.			

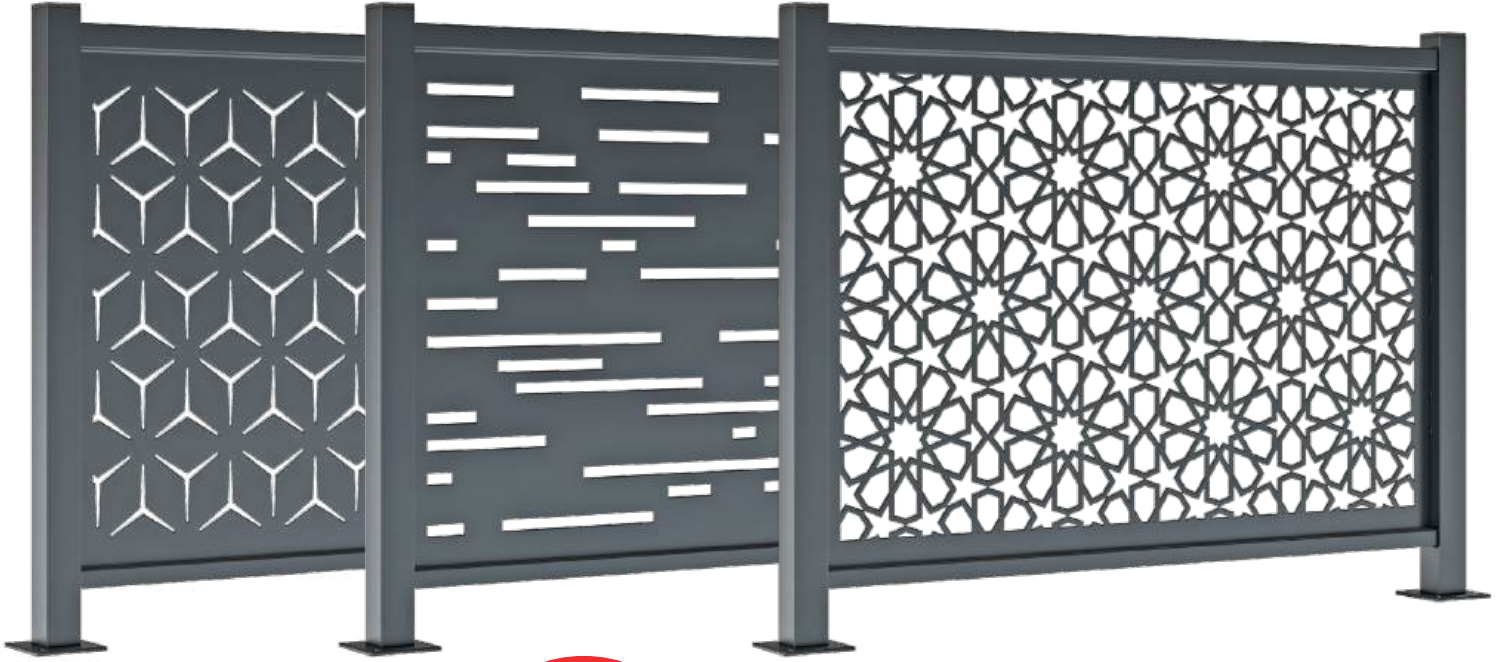

PROFİL

galvaniz profil
flanş kaynaklı

POST

galvanized profile
welded flange

İDA

lazer kesimli hazır paneller
laser-cut panels

Kendinden küpeşteli, lazer kesimli korkuluk sistemi, dekoratif ve fonksiyonel amaçlarla kullanılan, metal levhaların lazer teknolojisiyle istenilen desenlerde kesilerek oluşturulduğu modern bir korkuluk türüdür. Genellikle merdiven ve balkon korkulukları için tercih edilir.

Lazer kesimli korkuluk modellerimizin bileşenleri, son teknoloji lazer makinalarımızla yüksek hassasiyetle kesildikten sonra, bükümü yapıp montaja hazır hale getirilir.

Self-railing laser cut railing system is a modern railing type used for decorative and functional purposes, created by cutting metal sheets in desired patterns with laser technology. It is generally preferred for staircase and balcony railings.

The components of our laser cut railing models are cut with high precision using our state-of-the-art laser machines, then bent and made ready for assembly.



demonte sistem
diy system

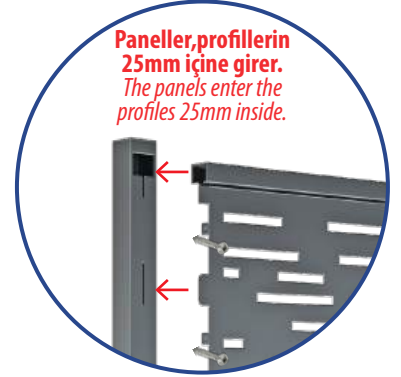

**Paneller,profillerin
25mm içine girer.**
The panels enter the
profiles 25mm inside.

kolay montaj
easy installation



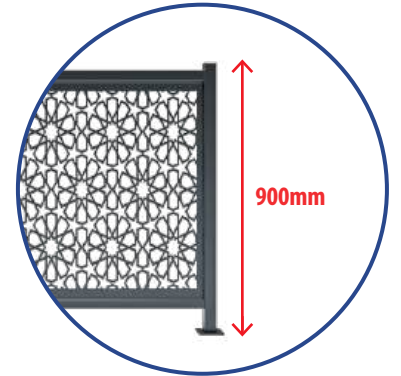

kendinden küpeşteli panel
self-rail panel

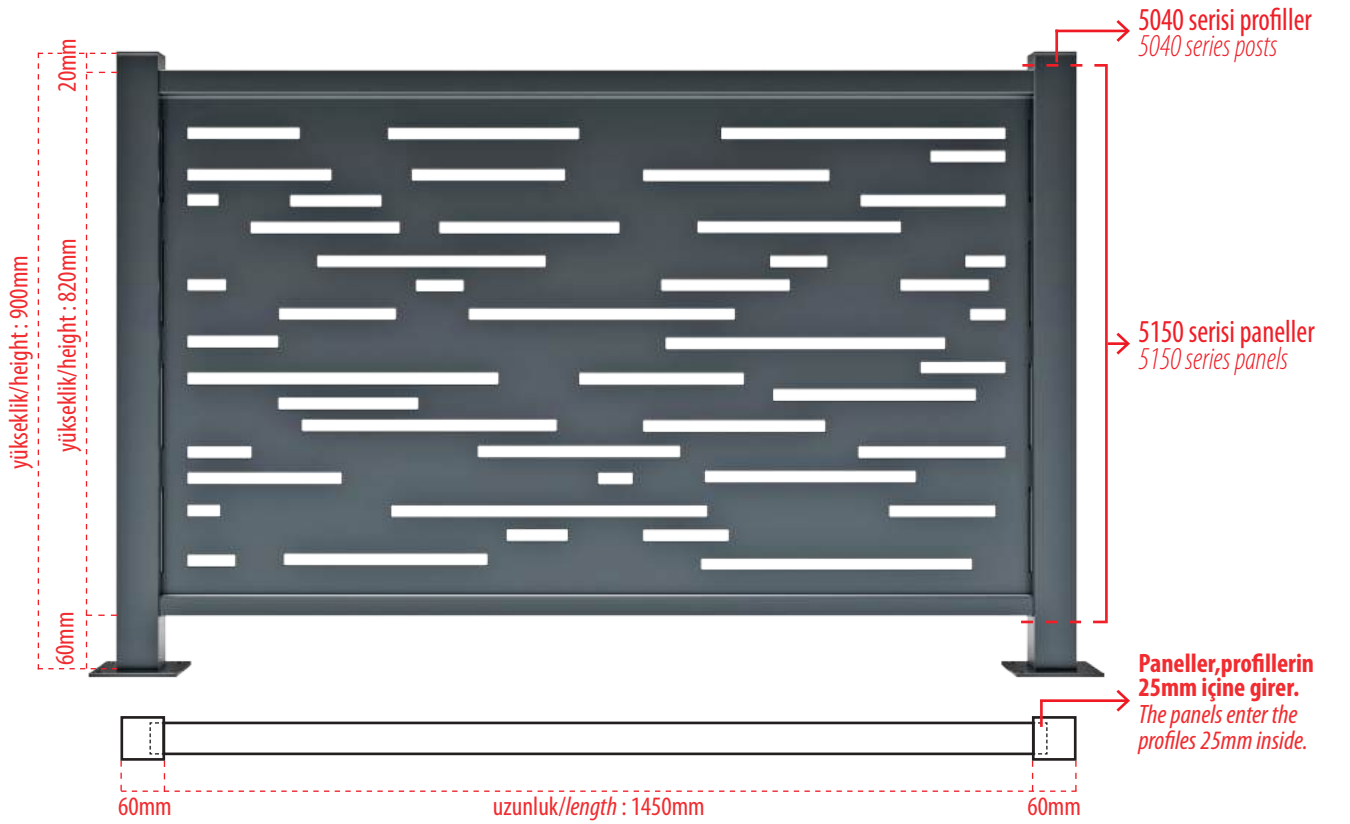

standart yükseklik
standard height

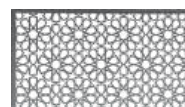

Profil Post		
Görsel Image	Kod Code	Yükseklik Height
	5040-900	900 mm
<p>***Standart profiller; 1.5mm kalınlıktaki 60x60mm galvanizli profilden üretilmektedir. *** Standard profiles are produced from 60x60mm galvanized profile with 1.5 mm thickness.</p> <p>***Her profil; kendinden kaynaklı 120x120x4mm flanşıyla ve 60x60mm plastik kapağıyla birlikte takım halindedir. ***Each post is supplied as a set with its own welded 120x120x4mm flange and 60x60mm plastic lid.</p>		

Lazer Kesimli Panel Laser-Cut Panel			
Kod Code	Desen Kodu Pattern Code	Yükseklik Height	Uzunluk Length
5150-1346		820 mm	1500 mm
5150-1762		820 mm	1500 mm
5150-1160		820 mm	1500 mm
<p>***Paneller; 2mm kalınlıktaki galvanizli sacdan üretilmektedir. ***Slats are produced from 2mm thickness galvanized sheet metal.</p> <p>***Projenize özel istenilen lazer kesim modeli ile boyalı veya boyasız üretim yapılabilir. ***It can be produced painted or unpainted, according to the laser-cut model requested for your project.</p>			



PROFİL

siyah kutu profil
flanş kaynaklı

POST

black box profile
welded flange

ALP

lazer kesimli hazır paneller
laser-cut panels

Lazer kesimli hazır paneller, genellikle modern ve estetik görünümleri ile dikkat çeker. İç ve dış mekanlarda veya balkonlarda uygulanabilir. Lazer kesimli korkuluklar, daha özgün ve kişiye özgü tasarımlara olanak sağlarken, dayanıklılığı ve uzun ömürlü olması sebebiyle oldukça kullanışlıdır.

Standart ölçü ve desenlerimizden seçim yapabileceğiniz gibi; projenize uygun farklı tasarımlar da üretilebilir.

Laser cut fence systems usually attract attention with their modern and aesthetic appearance. They can be applied in indoor and outdoor areas or on balconies. Laser cut railings allow for more original and personalized designs, and are quite useful due to their durability and longevity.

You can choose from our standard sizes and patterns, or it can be produce different designs to suit your project.



hazır montaj delikleri
ready installation holes

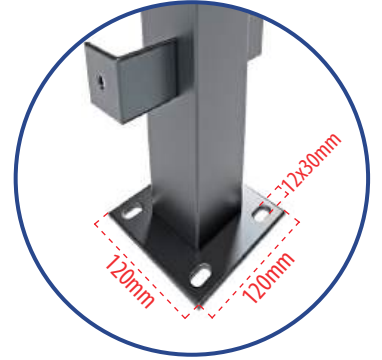

zemine kolay montaj
easy to install on ground

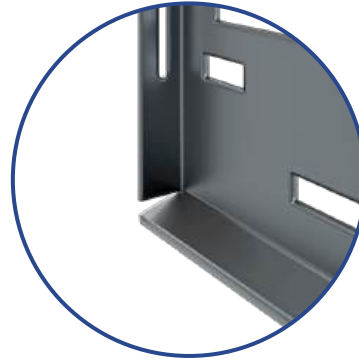

yağmur suyu birikmez
rainwater does not accumulate

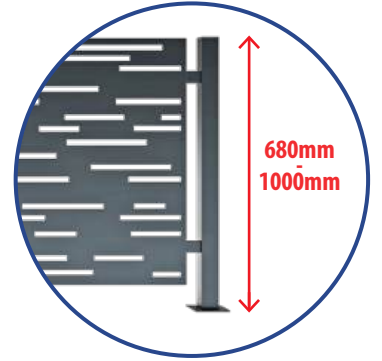

farklı yükseklik seçenekleri
different height options

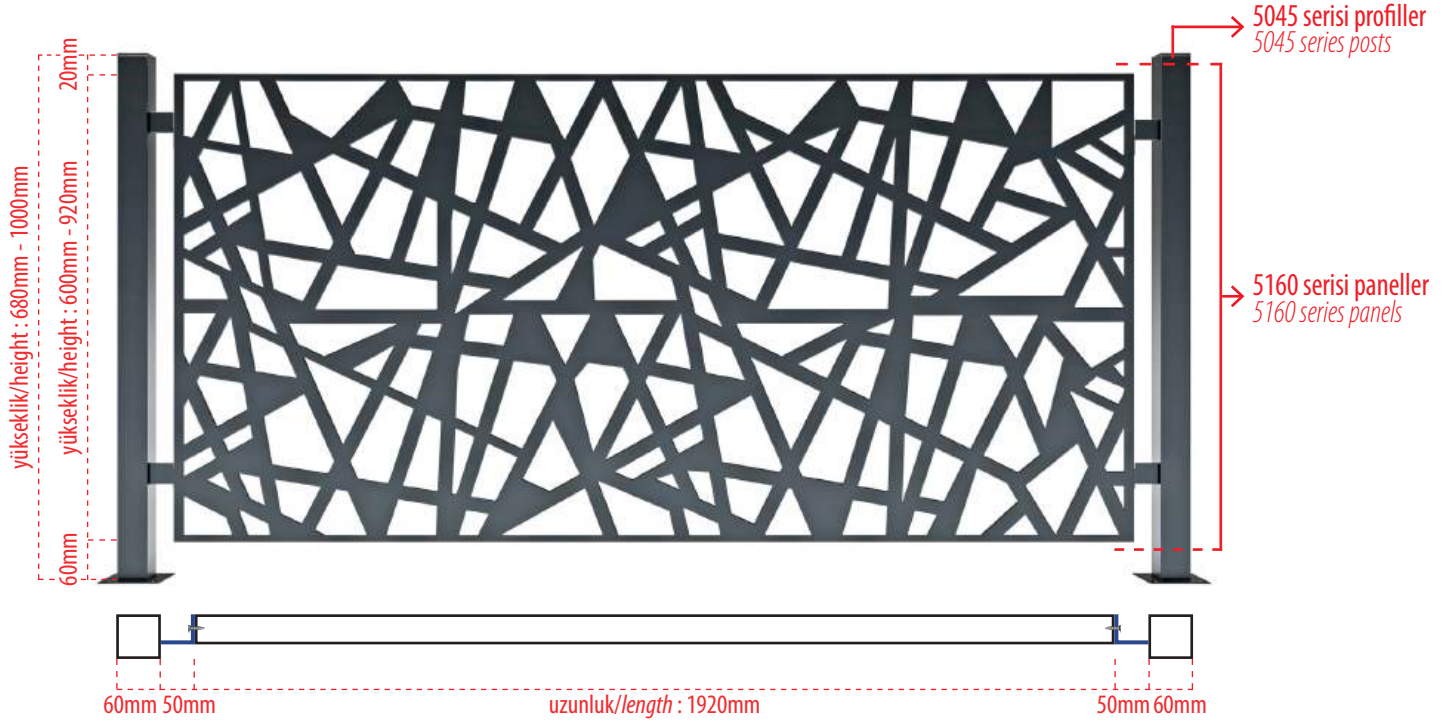

Profil Post				
Görsel Image			Kod Code	Yükseklik Height
A Tip A Type	B Tip B Type	C Tip C Type		
			5045-680	680 mm
			5045-880	880 mm
			5045-1000	1000 mm
<p>***Standart profiller; 1.5mm kalınlıktaki 60x60mm siyah kutu profilden üretilmektedir. İstenildiği takdirde sıcak daldırma galvaniz kaplama yapılabilir. *** Standard profiles are produced from 60x60mm black box profile with 1.5 mm thickness. Hot-dip galvanizing is available if required.</p> <p>***Her profil; kendinden kaynaklı L bağlantı parçası, 120x120x4mm taban flanş ve 60x60mm plastik kapağıyla birlikte takım halindedir. ***Each profile is supplied as a set with a self-welded L connection piece, 120x120x4mm base flange and 60x60mm plastic lid.</p>				

Lazer Kesimli Panel Laser-Cut Panel			
Kod Code	Desen Kodu Pattern Code	Yükseklik Height	Uzunluk Length
5160-600	 1762	600 mm	1920 mm
5160-800	 1252	800 mm	1920 mm
5160-920	 1160	920 mm	1920 mm
<p>***Standart paneller; 2mm kalınlıktaki siyah sacdan üretilmekte olup, 4 tarafı bükümlüdür. İstenildiği takdirde galvanizli sacdan da üretim yapılabilir. ***Standart panels are produced from 2mm black sheet metal and are bent on 4 sides.</p> <p>***Projenize özel istenilen lazer kesim modeli ile boyalı veya boyasız üretim yapılabilir. ***It can be produced painted or unpainted, according to the laser-cut model requested for your project.</p> <p>***Özel kulakçıklı yapısı ve montaj delikleri sayesinde kolay kurulum sağlar. *** With L design parts and mounting holes, it ensures easy installation.</p>			

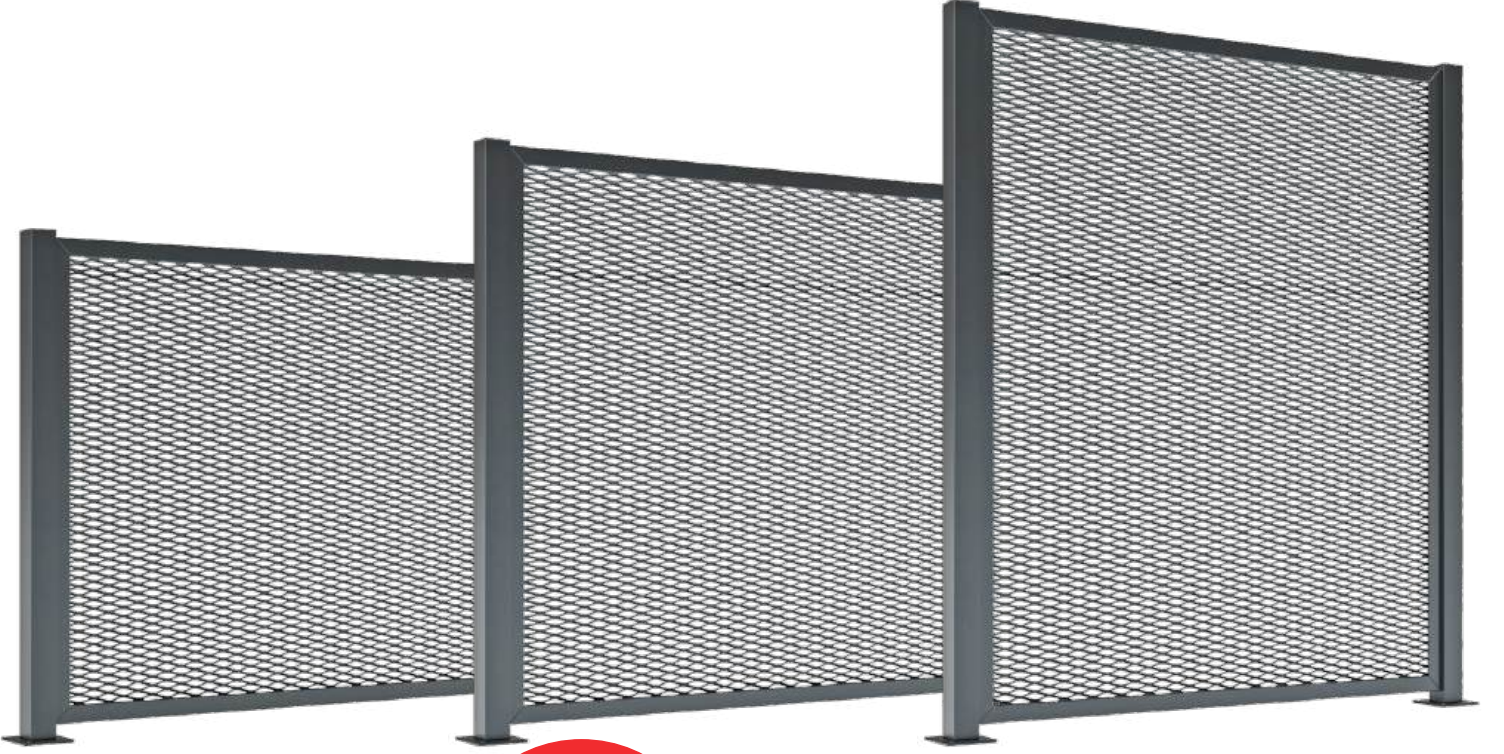
**PROFİL**

siyah kutu profil
flanş kaynaklı

POST

black box profile
welded flange

EVEREST

genişletilmiş metal panel
expanded metal panel

Genişletilmiş metal korkuluk sistemi, genellikle endüstriyel ve ticari mekanlarda güvenlik, estetik ve dayanıklılık sağlamak amacıyla kullanılır.

Sistem; genişletilmiş metalin, çerçeveye sabitlenmesiyle oluşturulmuştur. Genişletilmiş metal; yapısı itibarıyla hava akışını sağlaması, görüşü kısıtlamaması, hafif ama dayanıklılığıyla oldukça tercih edilen bir malzemedir.

Expanded metal railing system is generally used in industrial and commercial spaces to provide security, aesthetics and durability.

The system is created by fixing expanded metal to the frame. Expanded metal is a highly preferred material due to its structure, providing air flow, not restricting vision, and being lightweight but durable.

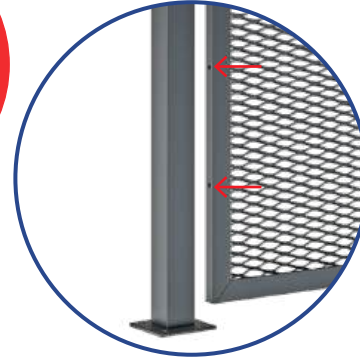

hazır montaj delikleri
ready installation holes

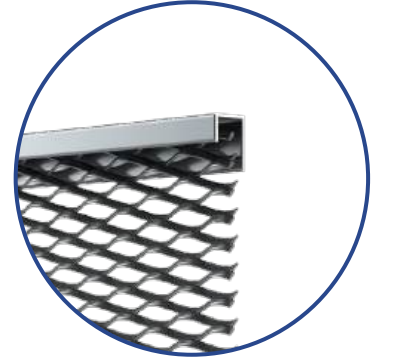

çerçevesel sistem
frame system

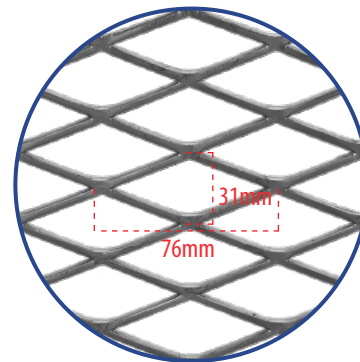

hava ve ışık geçirgenliği
air and light permeability

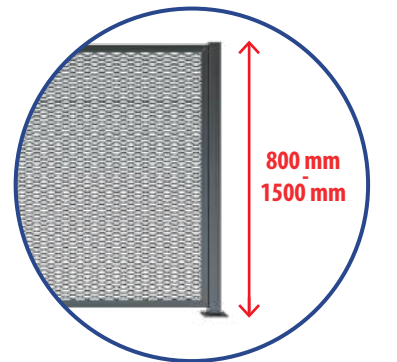

farklı yükseklik seçenekleri
different height options

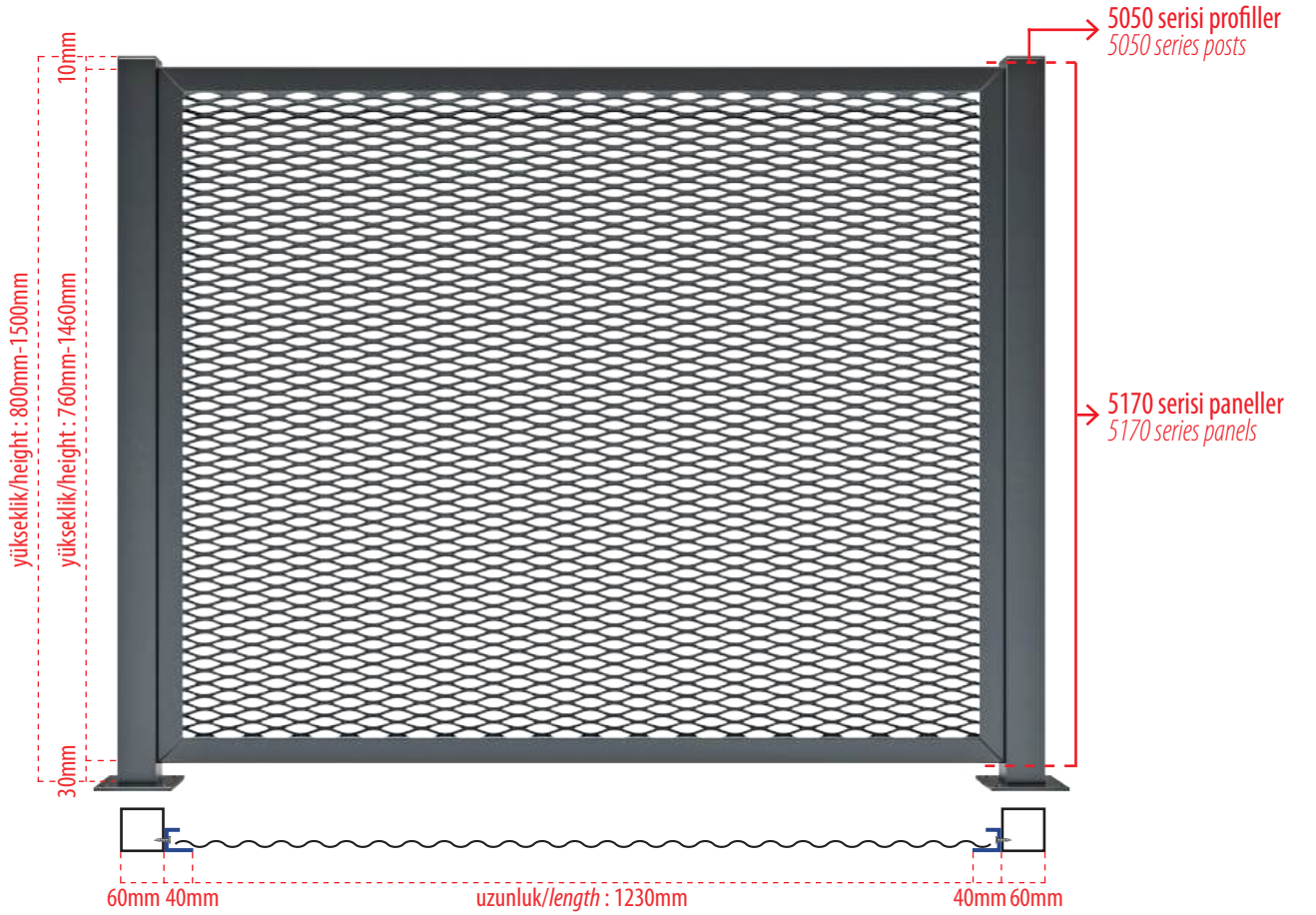

Profil Post		
Görsel Image	Kod Code	Yükseklik Height
	5050-800	800 mm
	5050-1000	1000 mm
	5050-1200	1200 mm
	5050-1500	1500 mm
<p>***Standart profiller; 1.5mm kalınlıktaki 60x60mm siyah kutu profilden üretilmektedir.</p> <p>*** Standard profiles are produced from 60x60mm black box profile with 1.5 mm thickness.</p> <p>***Her profil; kendinden kaynaklı 120x120x4mm flanşıyla ve 60x60mm plastik kapağıyla birlikte takım halindedir.</p> <p>***Each post is supplied as a set with its own welded 120x120x4mm flange and 60x60mm plastic lid.</p>		

Genişletilmiş Metal Panel Expanded Metal Panel			
Görsel Image	Kod Code	Yükseklik Height	Uzunluk Length
	5170-760	760 mm	1310 mm
	5170-960	960 mm	1310 mm
	5170-1160	1160 mm	1310 mm
	5170-1460	1460 mm	1310 mm
<p>***Paneller; 76/31mm göz aralığı ölçüsü olan 2mm kalınlıktaki genişletilmiş metalden üretilmekte olup, dış çerçevesi 2mm sacdan üretilmiştir.</p> <p>***Panels are produced from 2mm thick expanded metal with a mesh size of 76/31mm and the frame is produced from 2mm sheet metal.</p> <p>*** İstenilen farklı göz aralıklarında ve farklı kalınlıklarda boyalı veya boyasız üretim yapılabilir.</p> <p>***It can be produced painted or unpainted, in different desired mesh sizes and thicknesses.</p>			



FUJİ

plastik ferforje panel
plastic ferforge panel

Plastik ferforje; geleneksel demir ferforje görünümünü ve şıklığını, plastik malzemenin avantajlarıyla birleştiren bir korkuluk sistemidir.

Paslanmaz, boya ve bakım gerektirmez. Hafifliği ile montaj ve taşıma kolaylığı sağlar.

Plastic wrought iron is a fence system that combines the traditional look and elegance of wrought iron with the advantages of plastic material.

It is rust-proof and requires no painting or maintenance. Its light weight makes it easy to assemble and transport.



ekonomik fiyat
low cost



galvanizli statik boyalı profil
galvanized and painted profile



hafif
lightweight

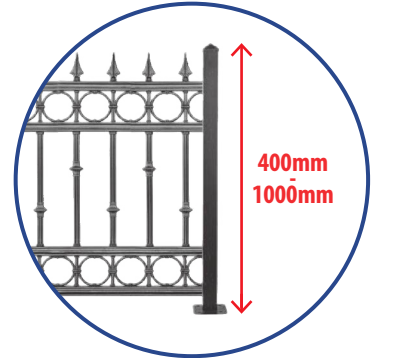

farklı yükseklik seçenekleri
different height options

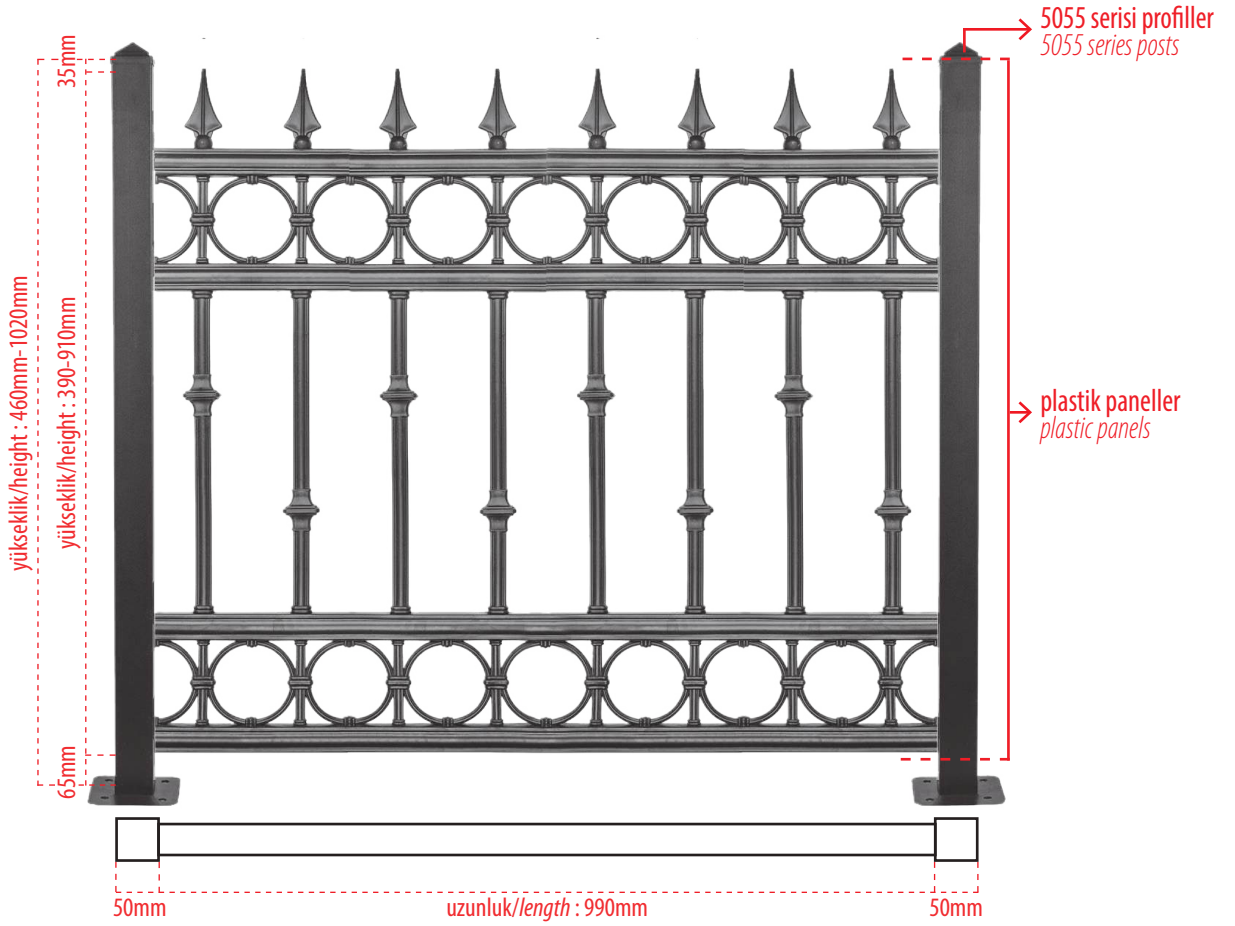

Profil Post			
Görsel Image	Kod Code	Yükseklik Height	Ağırlık Weight
	5055-460	460 mm	1,20kg
	5055-860	860 mm	2,00kg
	5055-1020	1020 mm	2,25kg
<p>***Standart profiller (50x50x1.5mm), statik boyalı ve kendinden kaynaklı flanşıyla ve plastik kapağıyla birlikte takım halinde.</p> <p>*** Standard posts (50x50x1.5mm) are painted and supplied as a set with its own welded flange and plastic lid.</p> <p>*** Standart olarak siyah renkte üretilmektedir. 350 metre ve üzeri siparişlerde özel renk üretimi yapılabilir.</p> <p>***It is produced in black color as standard. Special color production is available for orders of 350 meters and above.</p>			

Plastic Panel Plastic Panel				
Görsel Image	Kod Code	Yükseklik Height	Uzunluk Length	Ağırlık Weight
	5190-390	390 mm	990 mm	3,50kg
	5191-750	750 mm	990 mm	4,30kg
	5191-910	910 mm	990 mm	5,60kg
<p>***Paneller; plastikten üretilmiş olup, 4 parça halinde gelmektedir.</p> <p>***Panels are produced from plastic and comes in 4 pieces.</p> <p>***Paneller montaj için gerekli olan tüm elemanları ile birlikte takım halinde. (galvanizli ve plastik bağlantı gijonları, plastik bağlantı pulları, plastik somunları ve yan kapakları)</p> <p>***Panels are in a set with all the elements required for assembly. (galvanized and plastic connecting rods, plastic connecting washers, plastic tiejon nuts and side covers)</p>				

PLASTİK SUNDURMA

plastic canopy

Sundurma sistemleri, dış mekanlarda güneş ışığından veya rüzgar, yağmur gibi hava koşullarından korunmak amacıyla kullanılan yapısal elementlerdir. Plastik sundurmaların ayakları; polipropilen plastik enjeksiyon malzemeden üretilmekte olup, üzerindeki levha ise 4mm polikarbon levhadan oluşmaktadır.

Hafif, dayanıklı ve kurulumunun basit olması sebebiyle hem fonksiyonel hem de estetik açıdan avantajlar sunarak yaygın şekilde kullanılır.

Canopy systems are structural elements used outdoors to provide protection from sunlight or weather conditions such as wind and rain. The legs of plastic canopy are manufactured from polypropylene injection molded material, and the top sheet is made of 4mm polycarbonate.

They are widely used because they are lightweight, durable, and easy to install, offering advantages in terms of both functionality and aesthetics.

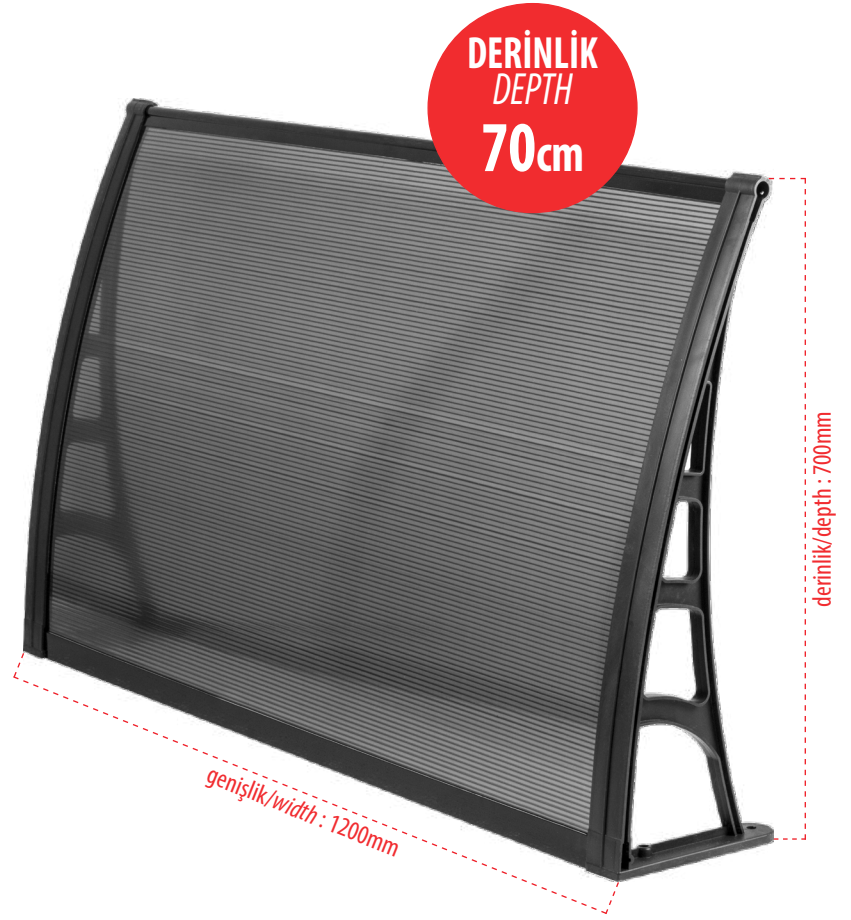

Sundurma Canopy			
Görsel Image	Kod Code	Derinlik Depth	Genişlik Width
	5200-700x1200	700 mm	1200 mm
	5200-700x2400	700 mm	2400 mm

***Ayaklar polipropilen plastik enjeksiyon malzemeden üretilmekte olup, siyah renktedir.

***Feet are made of polypropylene plastic injection material and are black in color.

***Çatı levhası 4mm polikarbon levha olmakla birlikte, isteğe göre şeffaf ve siyah renk seçenekleri mevcuttur.

***The roof sheet is 4mm polycarbonate sheet, transparent and black options are available upon request.

***120cm ve katlarında üretim yapılabilir.

***Production can be done in increments of 120 cm.

*** Tüm kurulum malzemeleri ile paket halinde teslim edilmektedir.

***It is delivered as a package with all installation materials included.

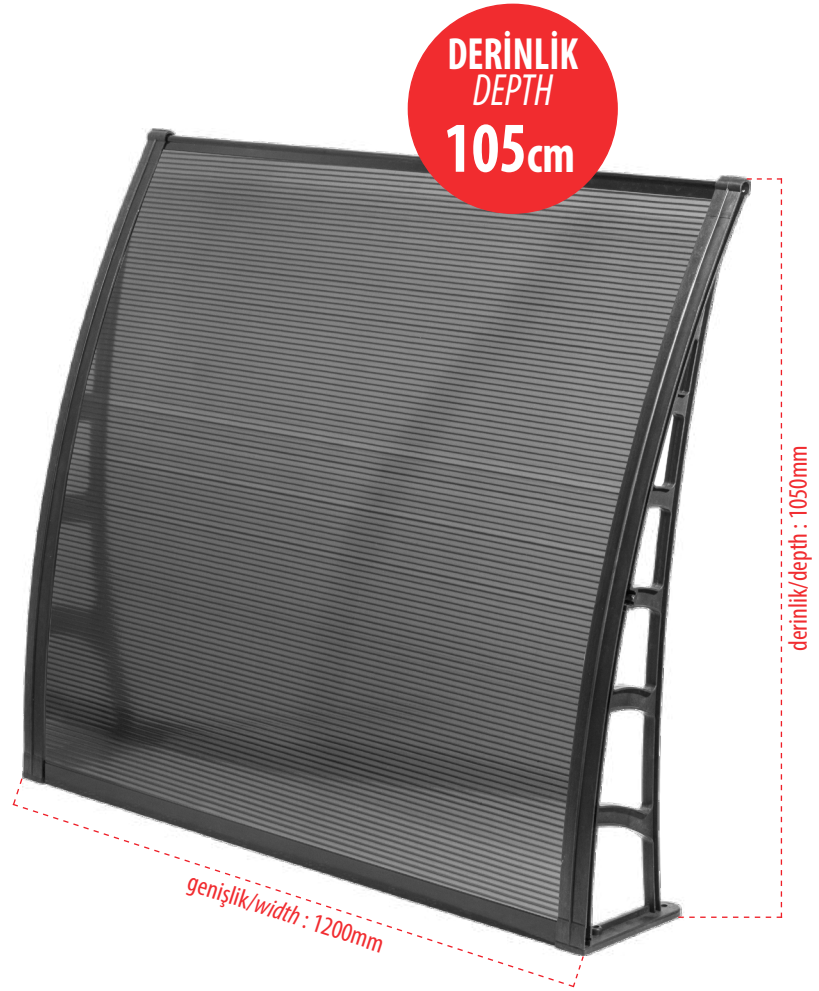
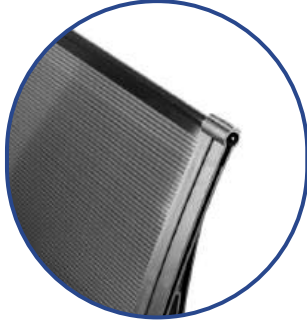
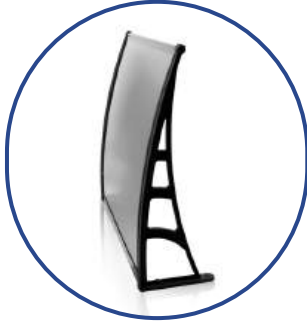

Sundurma Canopy			
Görsel Image	Kod Code	Derinlik Depth	Genişlik Width
	5201-1050x1200	1050 mm	1200 mm
	5201-1050x2400	1050 mm	2400 mm

***Ayaklar polipropilen plastik enjeksiyon malzemeden üretilmekte olup, siyah renktedir.

***Feet are made of polypropylene plastic injection material and are black in color.

***Çatı levhası 4mm polikarbon levha olmakla birlikte, isteğe göre şeffaf ve siyah renk seçenekleri mevcuttur.

***The roof sheet is 4mm polycarbonate sheet, transparent and black options are available upon request.

***120cm ve katlarında üretim yapılabilir.

***Production can be done in increments of 120 cm.

***Tüm kurulum malzemeleri ile paket halinde teslim edilmektedir.

***It is delivered as a package with all installation materials included.

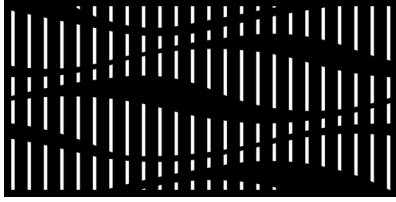

1005



1013

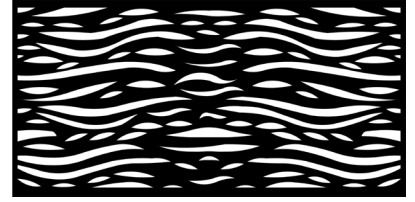

1019

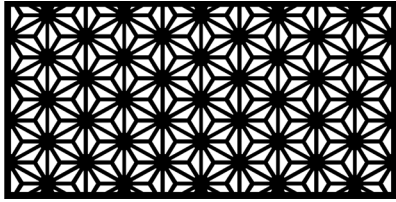

1023

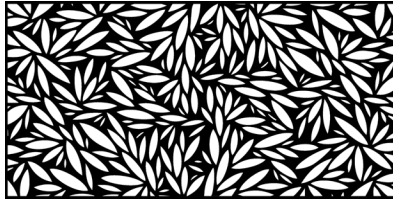

1087

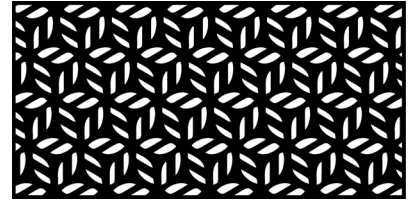

1092

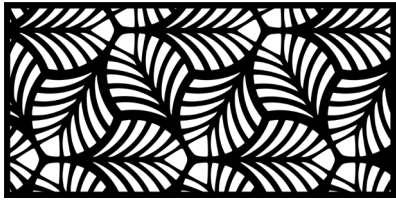

1097

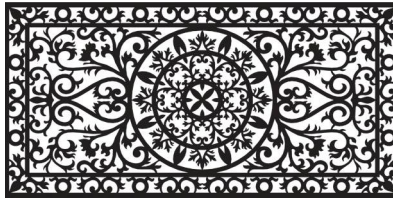

1101

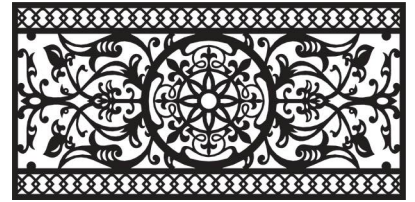

1125

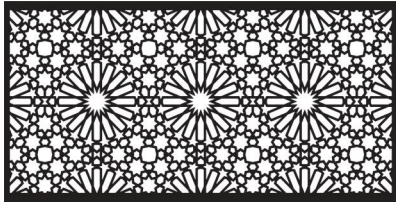

1158

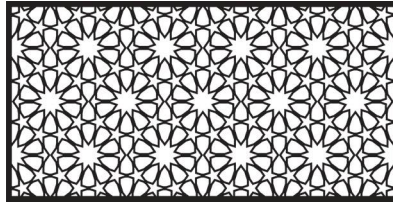

1160



1223



1238

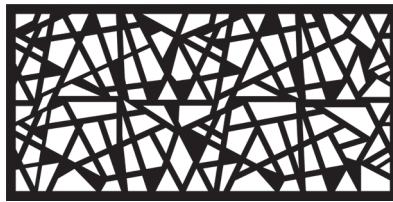

1252

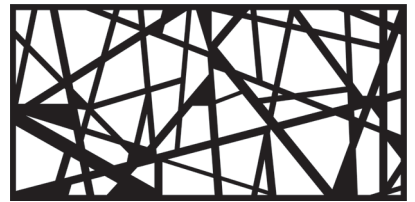

1253

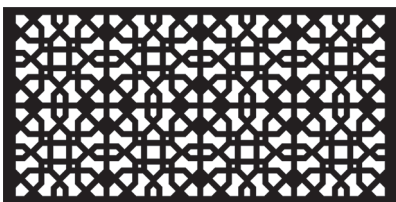

1255

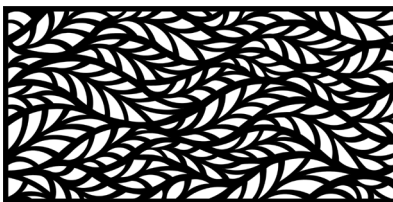

1295

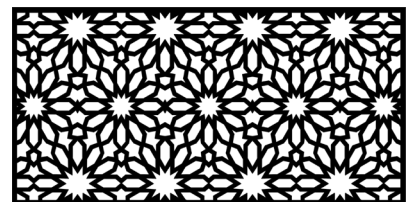

1298



1308

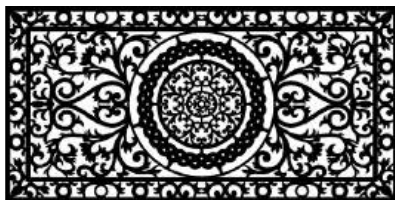

1312

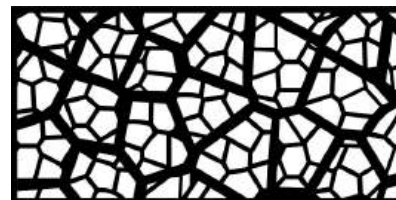

1323

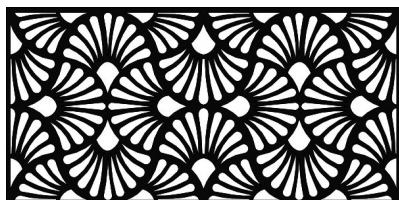

1342

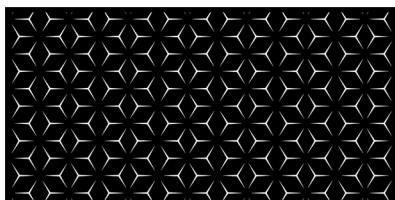

1346

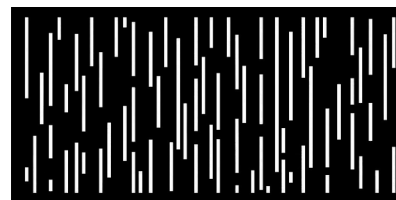

1348

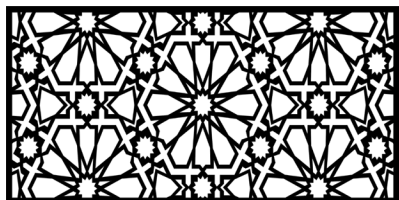

1349

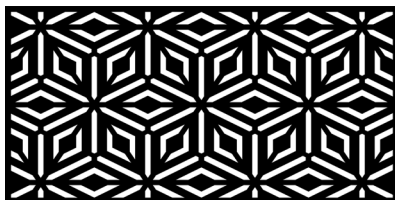

1356

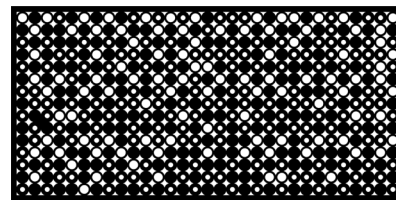

1388



1393



1466

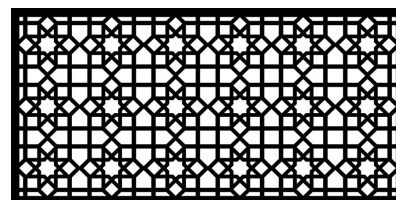

1471

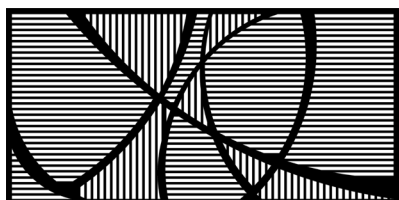

1472

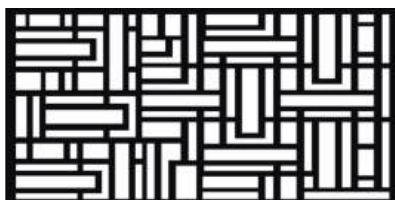

1480

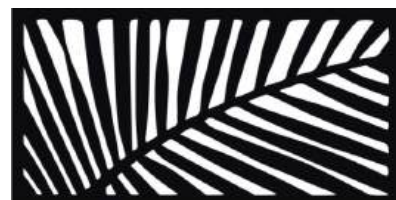

1491



1499



1762



1827



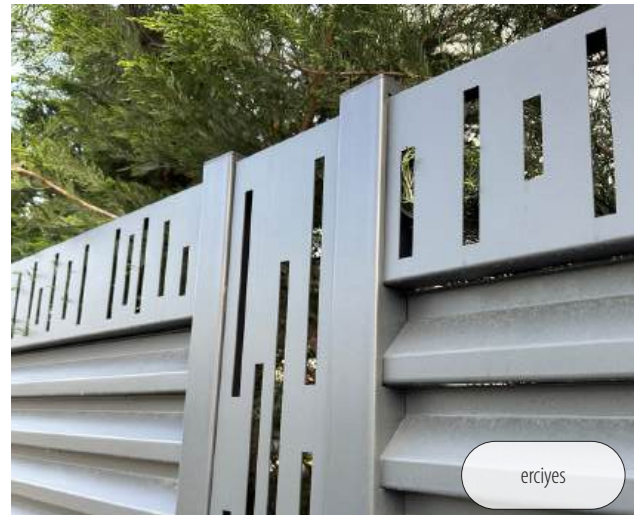



İnternet sayfamızı incelemek için lütfen QR kodu telefon kamerasına okutunuz.

Please scan the QR code with your phone camera to search our website.



KIRIMCI METAL FORM
SAN. ve TİC. AŞ.

Hasanağa Organize Sanayi Bölgesi
8. Cadde No.1 Nilüfer / Bursa / TURKEY

t. +90 224 482 26 02
t. +90 224 482 26 07

+90 531 624 65 88 (Export)
+90 534 088 74 98 (Yurtiçi Satış)

info@kirimcimental.com
www.kirimcimental.com